

Dear consumer:

Thank you for buying the 2M/2V/3M/3V multifunctional Digital Readout (DRO) products manufactured by our company. This kind of DRO is widely used on the machine tools such as milling machines, lathes, electric discharge machines, grinding machines, etc. and detecting equipments, as well as in the positional and auxiliary processing of manual operation.

Operation Manual:

This manual is the instruction for operation and use of 2M/2V and 3M/3V multifunctional DROs.

Mode D60-2V: 2 axis DRO, applicable to the 2 axis milling machines, grinding machines, lathes and the machines require 2 axes display.

Mode D60-3V: 3 axis DRO, applicable to the machines require 3 axis display, such as milling machines, lathes, Electrical Discharge Machines etc.

Safety Precautions:

In order to prevent electric shock or fire disasters, the DRO must be kept dry or not be splashed directly by the cooling liquid. In the case that the DRO emits smoke or peculiar smell, pull out the power plugs immediately to prevent fire disasters and electric shock. Then contact our company or the dealers, do not try to repair it by yourself.

The DRO is connected with the grating ruler or other displacement sensors to form the precise measuring system. Special attention should be paid when using the measuring system, and do protect the connection between the grating ruler and DRO from damage to avoid measuring errors.

Do not repair and modify the measuring devices of DRO by yourself, otherwise the failure, fault or damage will be caused. If any abnormality occurs, please contact our company or the dealers.

When the sensors (such as grating rulers, magnetic grating rulers, rotary encoders) used with the DRO device are damaged, do not use other brand products to replace the damaged ones, for the products of each company have different features, index, interface and modes. Please replace the damaged sensors under the professional's guidance; otherwise it is liable to cause damage to the DRO device.



ISO9001

D60-3V Panel of the DRO

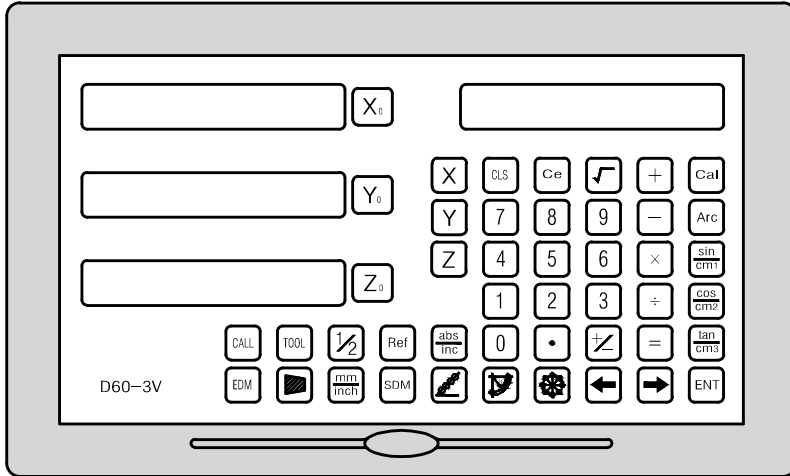

D60-2V Panel of the DRO

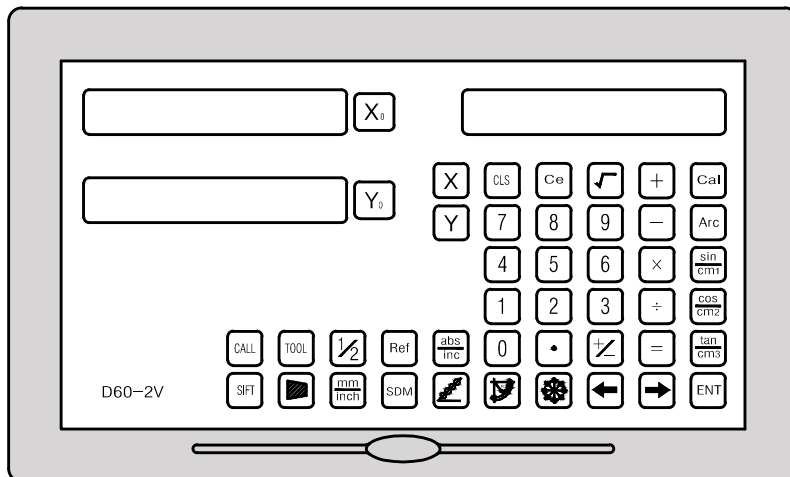

D60-3M Panel of the DRO

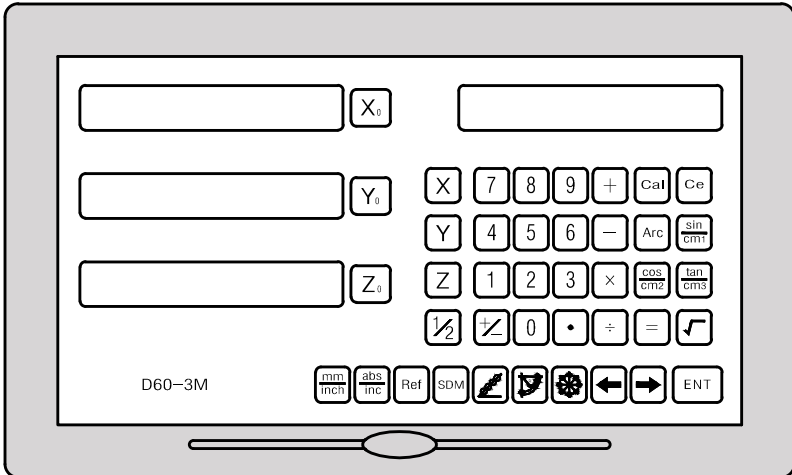

D60-2M Panel of the DRO

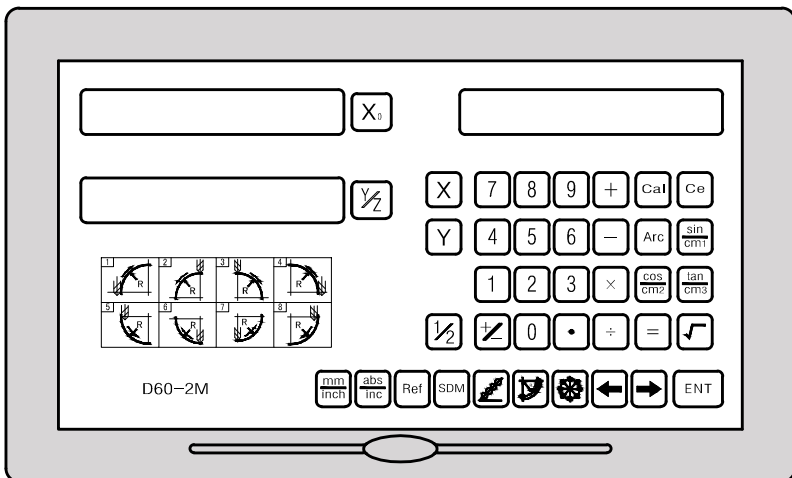



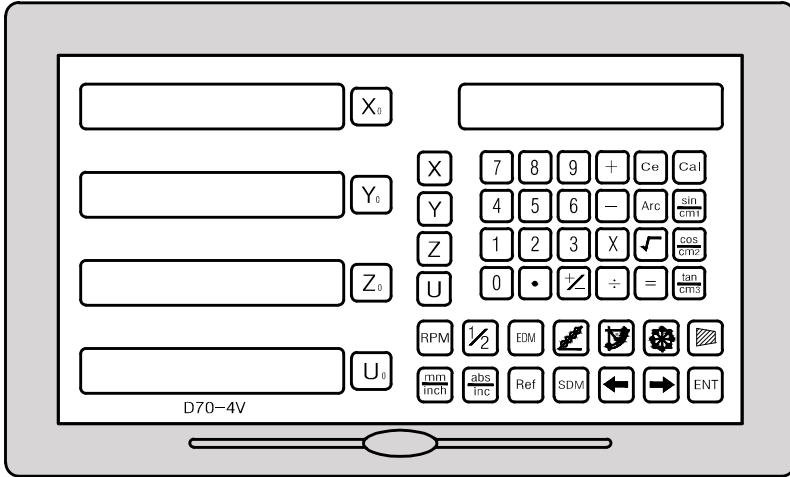











D70-4V Panel of the DRO









Instruction of Panel and keypad

Instruction of the keypad of the DRO

    _____ Axis selection key

    
     _____ Numeric key

     _____ Calculation key (calculator function)

 _____ Calculation key
(calculator function)

 _____ Zeroing key (calculator function)

 _____ Restore the trigonometric function (calculator function)

 _____ Square root calculation key
(calculator function)

 _____ Decimal point input key

 _____ Minus input key

 _____ Confirm key

Instruction of Panel and keypad



Delete the input value
(calculator function)



1/2 value calculation
function key



The Metric/British units
Switching key



Scale key / Sleeping
function key



200 Points Auxiliary Zero
Position Function key



Arc machining function (PRD)
key



Divide holes on Circumference
(PCD) function key
Y+Z enabling key (L series DROs)



Divide holes on an oblique line
(PLD) function key



This key is the sine function key in the
calculation function; Bevel machining
function key (M series DROs)



This key is the cosine function key in
the calculation function; Rectangular
box machining key (M series DROs)

Instruction of Panel and keypad



————— Tangent function key of calculation function



————— Absolute / relative coordinates transformation key



————— Selection key



————— Taper checking function key



————— Tool magazine input key



————— Tool magazine call key



————— Congruous Output Function in EDM (3V DROs)



————— Zeroing, resetting



————— Digital filtering function key (2V DROs)



————— D70-4V rotate speed measurement function

Content

1. Introduction about D60-M Series

1.1 2M DROs for 2 axis milling machines 1
1.2 3M DROs for 3 axis milling machines 2

D60-V Series

1.3 2V DROs for 2 axis lathes 3
1.4 2V DROs for 2 axis milling machines 4
1.5 2V DROs for 2 axis grinding machines 5
1.6 3V DROs for 3 axis lathes 6
1.7 3V DROs for 3 axis milling machines 7
1.8 3V DROs for EDM 8

D70-V Series

1.9 4V DRO used for revolving speed measurement 9

2. System Parameters Setting

2.1 Selection of Linear Encoder or Rotary Encoder 11
2.2 Resolution Setting 11
2.3 Counting Direction Selection 12
2.4 Compensation Type Setting 12
2.5 Parameter Setting of Rotary Encoder 13
2.6 DRO Type Selection 13

3. Basic Functions

3.1 Zeroing, Data Recovery 16
3.2 Display in Metric/British units 16
3.3 Input Coordinate 17
3.4 1/2 Function 17
3.5 ABS/INC Way 18
3.6 Full zeroing 200 points SDM 19
3.7 Power Off Memory Function 19

Content

3.8 Sleeping Function	19
3.9 Ref Ruler storage function	19
3.9.1 Find Zero Point of grating ruler (FIND.REF)	20
3.9.2 Find the Zero Point (RECALL)	21
3.10 Linear Compensation	23
3.11 Non-linear Compensation	25
3.12 200 Points Auxiliary Zero Position Function	28

4. Special Function

4.1 PLD Function	38
4.2 PCD Function	44
4.3 Smooth R Function	48
4.4 Simple R Function	63
4.5 Rectangle Chambering Function	71
4.6 Bevel Machining Function	74
4.7 Calculator Function	77

4.8 Special Functions for Grinding Machines

4.8.1 Digital Filtering Function	81
----------------------------------	----

4.9 Special Functions for Lathes

4.9.1 200 sets of tools	83
4.9.2 Toper Measuring Function	87
4.9.3 Radius/diameter Conversion Function	89
4.9.4 Y + Z function (special for 3 axis lathes)	90

4.10 EDM Function

4.10.1 Introduction and Operation sequences	92
---	----

5. D70-4V rotate speed measurement function

5.1 Brief Introduction Operation Processes	102
5.2 The installing drawing of Rotate Measurement Machinery	103

Content

6. Appendix

6.1 Specifications	104
6.2 Mechanical dimensions and Installation Drawing	104
6.3 Troubleshooting	105

1. Introduction

1. Introduction of 2-axis Milling Machine of D60-M series

1. Introduction:

The power switch of the DRO is located on its back. The DRO enters the self-checking state firstly after booting. After the self-checking state is completed, the window at the left side displays the resolution of X, Y and Z respectively, and the window on the right side displays the set machine tool type. D60-2M applies to 2-axis milling machines; D60-3M applies to 3-axis milling machines; D60-2G applies to 2-axis grinding machines; D60-3L applies to 3-axis lathes; D60-2L applies to 2-axis lathes and D60-3E applies to the electric discharge machines.

D60-M Series

1.1 2 - axis milling machine

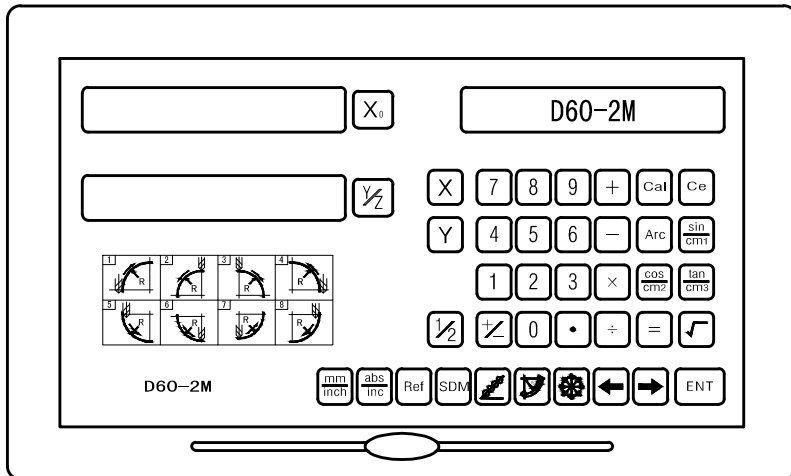

Apply to: 2 - axis milling machines, punching machines, etc.

Basic functions:

- 1) Zeroing;
- 2) Zeroing reset;
- 3) Metric/British units switching;
- 4) 1/2 function;
- 5) Dimension input;
- 6) ABS/INC coordinates conversion;
- 7) Power off memory;
- 8) Full zeroing of 200 sets SDM coordinate origins;
- 9) Sleeping mode;
- 10) Ruler storage function;
- 11) Linear compensation;
- 12) Non-linear compensation;
- 13) 200 sets of auxiliary coordinate;
- 14) Parameters Setting;

Special functions:

- 1) Bevel punching function;
- 2) Divide holes on Circumference (PCD) function;
- 3) Arc machining function;
- 4) Chamber step machining function;
- 5) Bevel machining function;
- 6) Calculator function;

Special keys:



1. Introduction of 3-axis Milling Machine of D60-M series

1.2 3 - axis milling machine

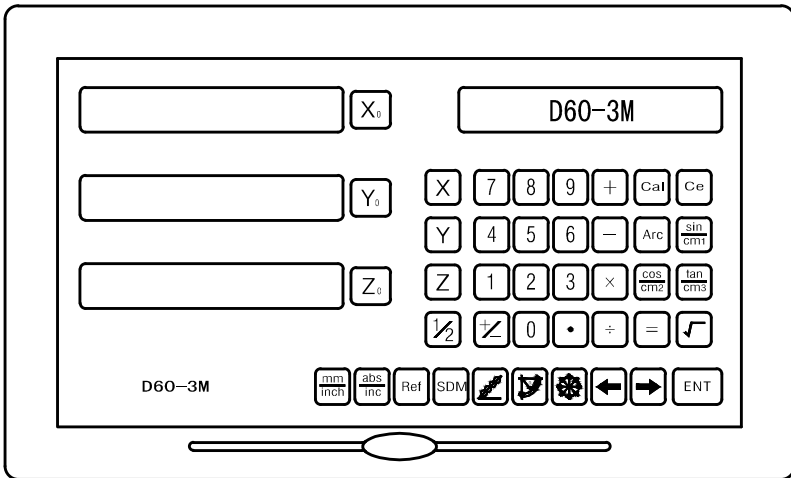

Apply to: 3 - axis milling machines, punching machines, etc.

Basic functions:

- 1) Zeroing;
- 2) Zeroing reset;
- 3) Metric/British units switching;
- 4) 1/2 function;
- 5) Dimension input;
- 6) ABS/INC coordinates conversion;
- 7) Power off memory;
- 8) Full zeroing of 200 sets SDM coordinate origins;
- 9) Sleeping mode;
- 10) Ruler storage function;
- 11) Linear compensation;
- 12) Non-linear compensation;
- 13) 200 sets of auxiliary coordinate;
- 14) Parameters Setting;

Special functions:

- 1) Bevel punching function;
- 2) Divide holes on Circumference (PCD) function;
- 3) Arc machining function;
- 4) Chamber step machining function;
- 5) Bevel machining function;
- 6) Calculator function;

Special keys:



D60-V Series

1.3 2 - axis lathe

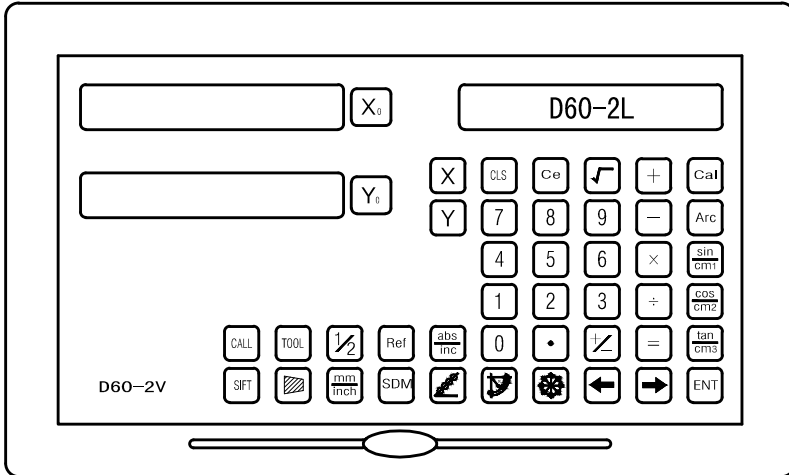

Apply to: 2 - axis lathe

Basic functions:

- 1) Zeroing;
- 2) Zeroing reset;
- 3) Metric/British units switching;
- 4) Dimension input;
- 5) ABS/INC coordinates conversion;
- 6) Power off memory;
- 7) Full zeroing of 200 sets SDM coordinate origins;
- 8) Sleeping mode;
- 9) Ruler storage function;
- 10) Linear compensation;
- 11) Non-linear compensation;
- 12) 200 sets of auxiliary coordinate;
- 13) Parameters Setting;

Special functions:

- 1) Magazine including 200 sets of tools;
- 2) Diameter/ radius conversion;
- 3) Toper measuring;
- 4) Calculator function;

Special keys:



1. Introduction of 2-axis Milling Machine of D60-V series

1.4 2 - axis milling machine

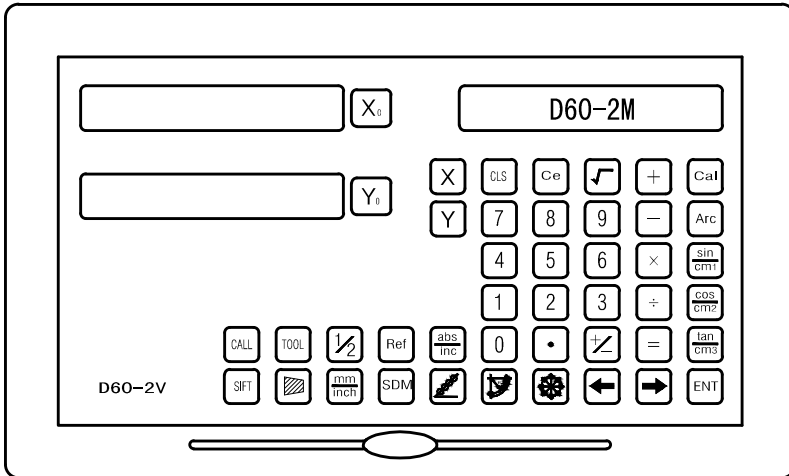

Apply to: 2 - axis milling machines, punching machines, etc.

Basic functions:

- 1) Zeroing;
- 2) Zeroing reset;
- 3) Metric/British units switching;
- 4) 1/2 function;
- 5) Dimension input;
- 6) ABS/INC coordinates conversion;
- 7) Power off memory;
- 8) Full zeroing of 200 sets SDM coordinate origins;
- 9) Sleeping mode;
- 10) Ruler storage function;
- 11) Linear compensation;
- 12) Non-linear compensation;
- 13) 200 sets of auxiliary coordinate;
- 14) Parameters Setting;

Special functions:

- 1) Bevel punching function;
- 2) Divide holes on Circumference (PCD) function;
- 3) Arc machining function;
- 4) Chamber step machining function;
- 5) Bevel machining function;
- 6) Calculator function;

Special keys:



1. Introduction of 2-axis grinding machine of D60-V series

1.5 2-axis grinding machine

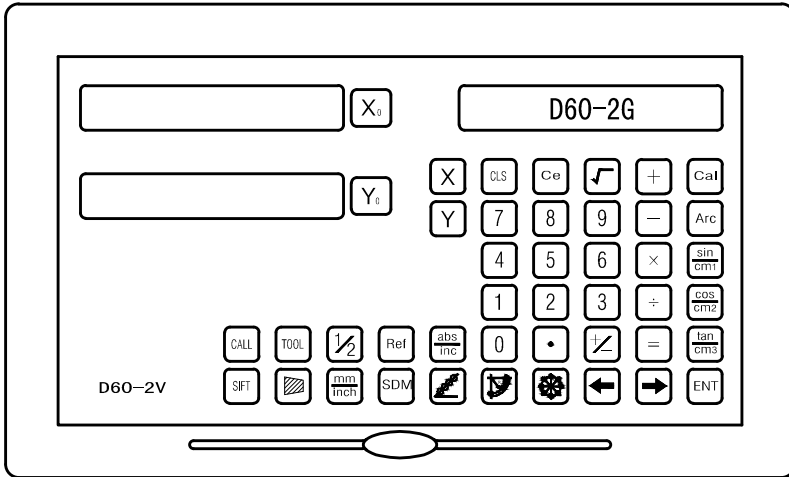

Apply to: 2-axis grinding machine

Basic functions:

- 1) Zeroing;
- 2) Zeroing reset;
- 3) Metric/British units switching;
- 4) 1/2 function;
- 5) Dimension input;
- 6) ABS/INC coordinates conversion;
- 7) Power off memory;
- 8) Full zeroing of 200 sets SDM coordinate origins;
- 9) Sleeping mode;
- 10) Ruler storage function;
- 11) Linear compensation;
- 12) Non-linear compensation;
- 13) 200 sets of auxiliary coordinate;
- 14) Parameters Setting;

Special functions:

- 1) Digital filtering; (eliminating the display maladjustment caused by the shake of the grinding machine);
- 2) Calculator function;

Special keys:



1. Introduction of 3-axis lathe of D60-V series

1.6 3-axis lathe

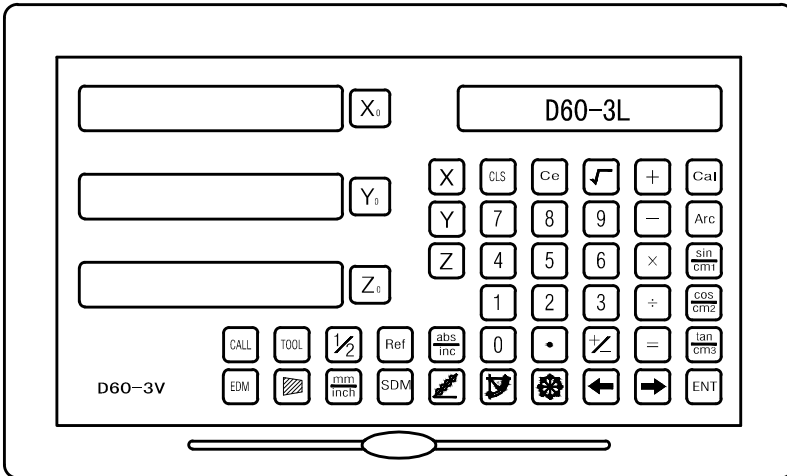

Apply to: 3-axis lathe

Basic functions:

- 1) Zeroing;
- 2) Zeroing reset;
- 3) Metric/British units switching;
- 4) Dimension input;
- 5) ABS/INC coordinates conversion;
- 6) Power off memory;
- 7) Full zeroing of 200 sets SDM coordinate origins;
- 8) Sleeping mode;
- 9) Ruler storage function;
- 10) Linear compensation;
- 11) Non-linear compensation;
- 12) 200 sets of auxiliary coordinate;
- 13) Parameters Setting;

Special functions:

- 1) Magazine including 200 sets of tools;
- 2) Diameter/ radius conversion;
- 3) Taper measuring;
- 4) Calculator function;
- 5) Y+Z function;

Special keys:



1. Introduction of 3-axis Milling Machine of D60-V series

1.7 3 - axis milling machine

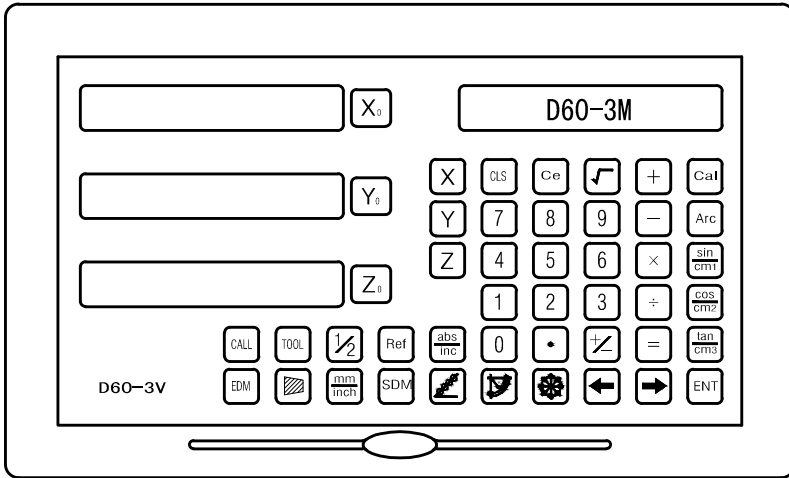

Apply to: 3 - axis milling machines, punching machines, etc.

Basic functions:

- 1) Zeroing;
- 2) Zeroing reset;
- 3) Metric/British units switching;
- 4) 1/2 function;
- 5) Dimension input;
- 6) ABS/INC coordinates conversion;
- 7) Power off memory;
- 8) Full zeroing of 200 sets SDM coordinate origins;
- 9) Sleeping mode;
- 10) Ruler storage function;
- 11) Linear compensation;
- 12) Non-linear compensation;
- 13) 200 sets of auxiliary coordinate;
- 14) Parameters Setting;

Special functions:

- 1) Bevel punching function;
- 2) Divide holes on Circumference (PCD) function;
- 3) Arc machining function;
- 4) Chamber step machining function;
- 5) Bevel machining function;
- 6) Calculator function;

Special keys:



1. Introduction of EDM of D60-V series

1.8 EDM DRO

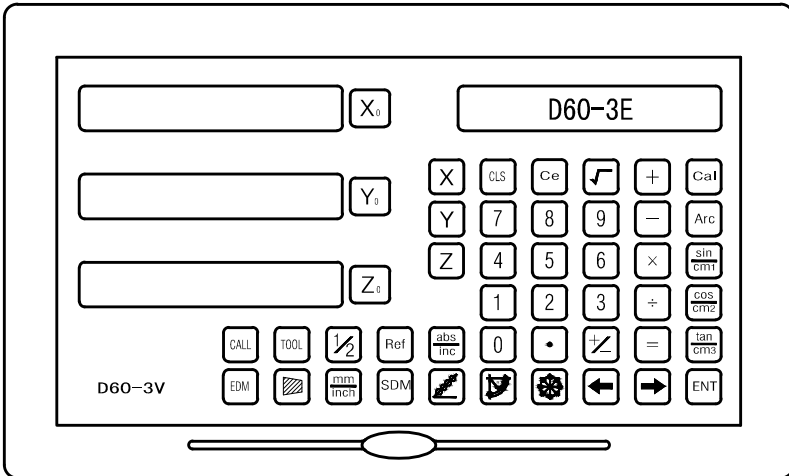

Apply to: EDM

Basic functions:

- 1) Zeroing;
- 2) Zeroing reset;
- 3) Metric/British units switching;
- 4) 1/2 function;
- 5) Dimension input;
- 6) ABS/INC coordinates conversion;
- 7) Power off memory;
- 8) Full zeroing of 200 sets SDM coordinate origins;
- 9) Sleeping mode;
- 10) Ruler storage function;
- 11) Linear compensation;
- 12) Non-linear compensation;
- 13) 200 sets of auxiliary coordinate;
- 14) Parameters Setting;

Special functions:

- 1) Bevel punching function;
- 2) PCD function;
- 3) Calculator function;
- 4) Electric discharge machine (EDM) function;

Special keys:



1. Brief Introduction of the D70-V series DR0

1.9 D70-V series DR0 of rotate speed measurement

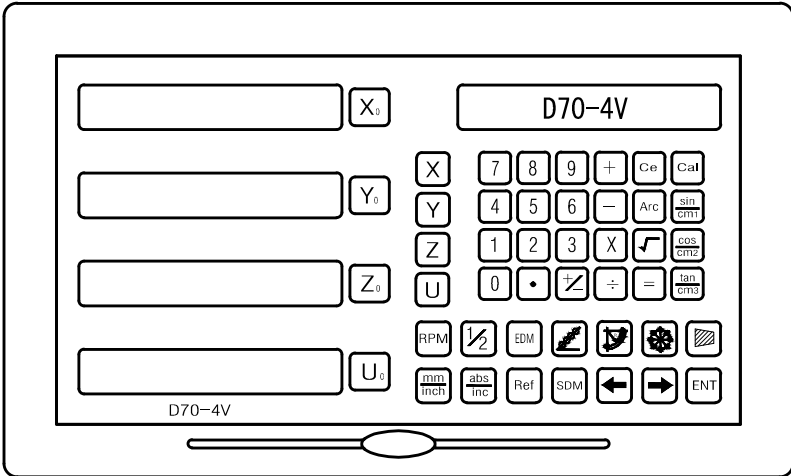

Apply to: milling machines, lathe, EDM

Basic functions:

- 1) Zeroing;
- 2) Zeroing reset;
- 3) Metric/British units switching;
- 4) 1/2 function;
- 5) Dimension input;
- 6) ABS/INC coordinates conversion;
- 7) Power off memory;
- 8) Full zeroing of 200 sets SDM coordinate origins;
- 9) Sleeping mode;
- 10) Ruler storage function;
- 11) Linear compensation;
- 12) Non-linear compensation;
- 13) 200 sets of auxiliary coordinate;
- 14) Parameters Setting;

Special functions:

- 1) Bevel punching function;
- 2) PCD function;
- 3) Calculator function;
- 4) Electric discharge machine (EDM) function;
- 5) Rotate Speed Measurement;

Special keys:



2. System parameter setting

2. System parameter setting

2. System parameter setting

The power switch of the DRO is located on its back. The DRO enters the self-checking state firstly after booting, which includes checking whether the LED display is normal and whether the setting of system resolution and model is appropriate. The self-checking state will sustain until DRO enters normal display state.

Press the  key once during the self-checking process, then the DRO will enter system parameter setting state. (Note that pressing just once is OK. If pressing twice, the system will skip the self-checking process and enter normal display state.)

In the system parameter setting, we can set parameters as follows: 1) encoder type selection (linear encoder or rotary encoder); 2) resolution setting (Fixed resolution: 0.1um, 0.2um, 0.5um, 1um, 2um, 2.5um, 5um and 10um.); 3) Counting direction setting (0 indicates positive direction, 1 indicates negative direction); 4) compensation type setting (linear or nonlinear compensation); 5) parameter setting of rotary encoder; 6) DRO type selection;

2.1: Encoder type selection (LINER stands for a linear displacement transducer matching the axis. Rotary stands for a rotary encoder matching the axis);

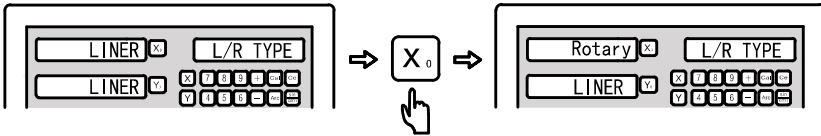

Press  key to alter the encoder type of X axis;

Press  key to alter the encoder type of Y axis;



Press  key to alter the encoder type of Z axis;

Press  key to enter step 2 and press  key to save and exit parameter setting.

2.2: Resolution setting (Set resolution for the corresponding encoder)

For linear encoder, set the resolution as follows:

Fixed resolution selection: 0.1um, 0.2um, 0.5um, 1um, 2um, 2.5um, 5um and 10um.

Press  key to alter the resolution of X axis. Press  key to alter the resolution of Y axis. Press  key to alter the resolution of Z axis.

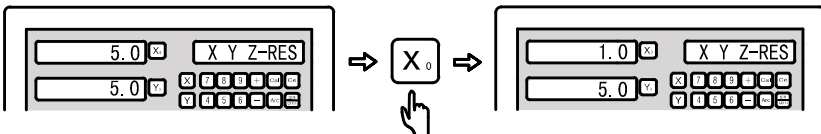

For rotary encoder, set the resolution as follows: (set the resolution of the rotary encoder in the following way). The rotary encoder can display in two ways. When entering the resolution in the way of positive number, the rotary encoder displays in degree (D). When entering the resolution in the way of negative number, the rotary encoder displays in degrees/minutes/seconds (DMS).

2. System parameter setting

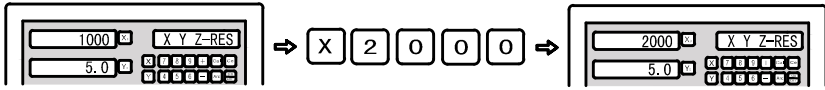

Press key to enter step 3 and key to save and exit parameter setting.

2.3: Counting direction selection

When selecting counting direction, it is divided into positive and negative direction (0 on the left window indicates positive counting direction of the window. 1 on the left window indicates negative counting direction of the window.) The operations are shown in the chart below.

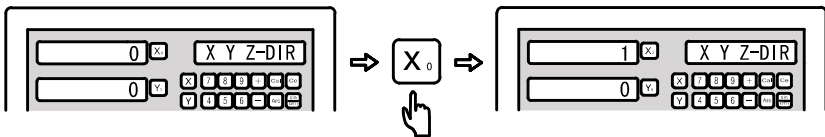

Press key to alter the counting direction of X axis.

Press key to alter the counting direction of Y axis

Press key to alter the counting direction of Z axis.

Press key to enter step 4 and press key to save and exit parameter setting.

2.4: Compensation type setting: (Select linear or nonlinear compensation)

When entering the compensation type setting, LINE on the left window indicates linear compensation for the window. UN-LINE on the left window indicates nonlinear compensation for the window. The operations are shown in the chart below.

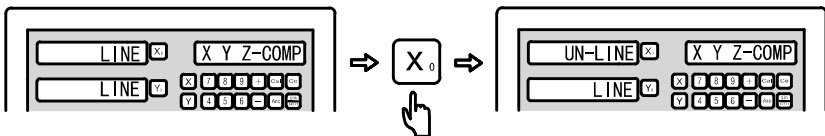

LINE: select linear compensation type: (see detailed operation in linear compensation setting section)

UN-LINE: select nonlinear compensation type: (see detailed operation in nonlinear compensation setting section)

Press key to alter the selection of X axis.

Press key to alter the selection of Y axis.

Press key to alter the selection of Z axis.

Press key to save and exit parameter setting and back to the user interface.

2. System parameter setting

2.5: Parameter setting of rotary encoder

Enter system parameter setting and select rotary encoder. Information screen displays L/R TYPE and X axis displays Rotary, then press  key to enter the resolution setting of the rotary encoder when information screen displays XYZ-RES. The resolution varies among different types of encoder, so you have to enter resolution for the corresponding rotary encoder type. When entering resolution, negative value results in degrees/minutes/seconds (DMS) counting mode and positive value results in degree (D) counting mode. This DRO supports a maximum resolution of 99999.

Example: Set the resolution of rotary encoder as 1000P/R

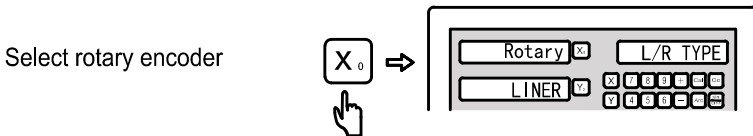

Input the resolution of X axis as +1000 and -1000 to Y axis

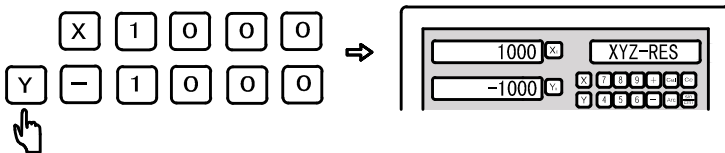



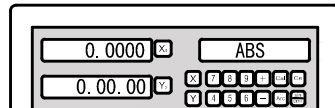

After inputting the resolution press  key to exit system parameter setting and back to the main menu.

X axis counts in degree (D) mode and Y axis counts in degrees, minutes and seconds (DMS) mode



2.6: DRO type selection

D60-3V multifunction DRO applies to 3-axis milling machines (D60-3M), 3-axis lathes (D60-3L) and EDMs (D60-3E). D60-2V multifunction DRO applies to 2-axis milling machines (D60-2M) and 2-axis lathes (D60-2L) and 2-axis grinding machines (D60-2G).

D60-3V and D60-2V multifunction DROs are easy to set and apply to milling machine, lathe, grinding machine and EDM etc. After booting, press  key once to enter the DRO type selection, then press  and  keys to select the type until the required type appears on the right and press  key to save and exit to the main menu.

2. System parameter setting

DRO type selection

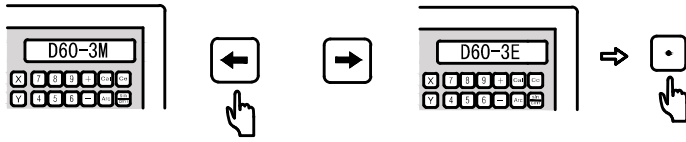

3. Basic functions

3. Basic functions

3. Basic functions

3.1 Zeroing, data recovery

Function: Operator could zero the displayed coordinate at any position.

Example 1: Zero the displayed value of X axis at the current position.

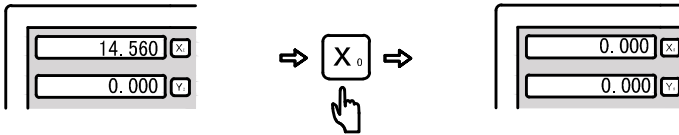

Press **[Y₀]** key to zero the displayed data of Y axis;

Press **[Z₀]** key to zero the displayed data of Z axis;

Data recovery

Function: Recover the data which has been zeroed by mistake at any position.

Example 2: Realize the data recovery of X axis.

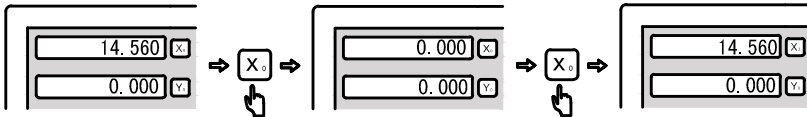

Press **[Y₀]** key to recover the displayed data of Y axis;

Press **[Z₀]** key to recover the displayed data of Z axis;

3.2 Display in Metric/British units

Function: Display the location size in Metric (mm) or British (inch) units.

Example 1: Switch the British (inch) units currently displayed to the Metric (mm) units.

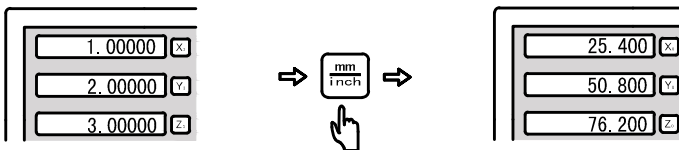

Example 2: Switch the Metric (mm) units currently displayed to the British (inch) units.

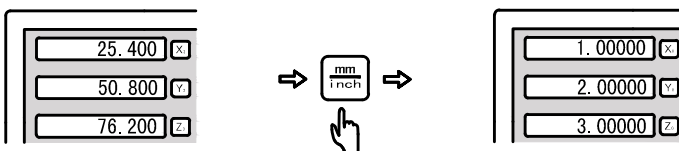

3. Basic functions

3.3 Input coordinates

Function: Enable the operator to set the current position at any value.

Example 1: Set the position of the current X axis as 16.800 .

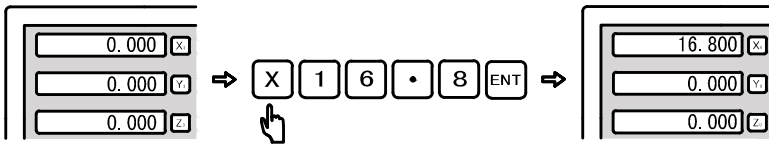

Example 2: Set the position of the current Y axis as -6.800 .

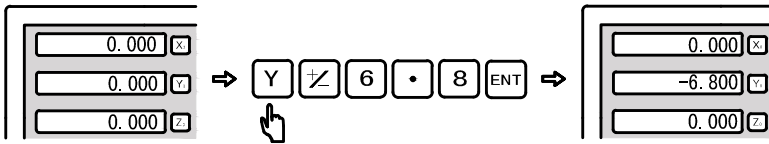

Example 3: Set the position of the current Z axis as 8.250 .

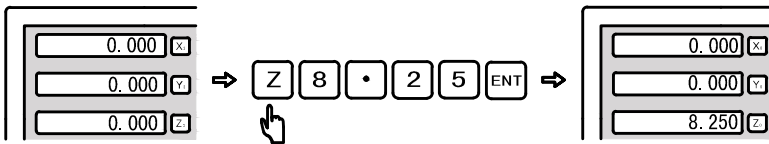

3.4 Automatic Centre Find

Function: DRO provides automatic centre find function which divides the current displayed position by 2 and sets the zero point at the centre of work piece.

Example 1: Set the zero point of X axis at the centre of work piece

Step 1: Align the optical edge finder on one side of X axis of work piece then clear to zero.

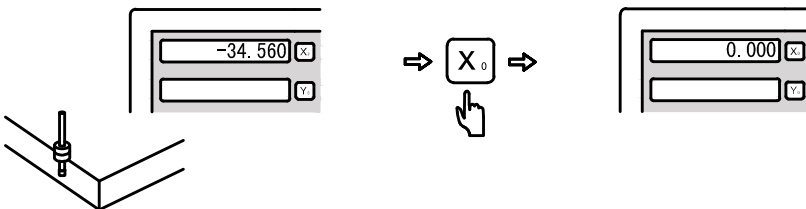

Step 2: Align the optical edge finder on the other side of X axis of work piece.

3. Basic functions

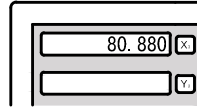
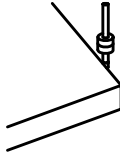

Step 3: Divide the current display of X axis by 2 according to centre find function.

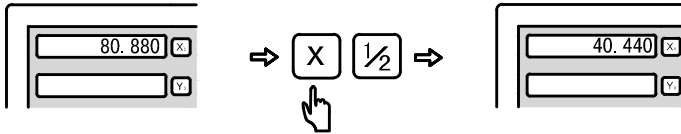

The X-axis centre of the work piece is 0.000. Move the grating ruler to 0.000, which is the centre of the work piece.

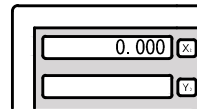
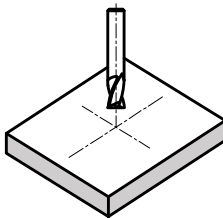

3.5 ABS/INC Coordinates

Function: DRO provides two sets of standard coordinate display value, namely ABS (absolute) and INC (relative) coordinates. The operator could store the reference zero point of work piece at ABS coordinate, and convert ABS coordinate to INC coordinate for machining. Zeroing at any position at INC coordinate won't affect the length value relative to the reference zero point of work piece at ABS coordinate, which shall be stored during the whole machining process and could be checked whenever necessary.

Example 1: Press  key to convert the current ABS coordinate to INC coordinate

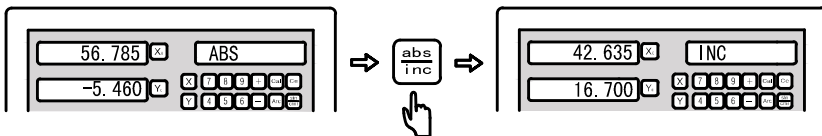

Example 2: Press  key to convert the current INC coordinate to ABS coordinate

3. Basic functions

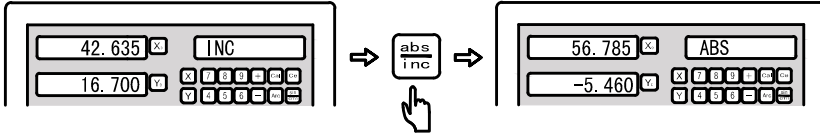

3.6 Full zeroing of 200 sets of auxiliary zero points of SDM



Under ABS state press  for 10 times. When information screen displays CLR SDM, it testifies that 200 sets of auxiliary zero locations has all been cleared.

3.7 Power Off Memory Function

In case of sudden powering off during machining process, DRO provides data storage module which could store the coordinate and data before powering off. When DRO is powered on again, all the data before powering off will recover automatically.

3.8 Sleeping function

Function: The operator could switch off DRO temporarily during the period when he leaves the machine. (Under non-ABS mode)

Example: Press  key to pause DRO under non-ABS state. Press  key again to return to machining state. When DRO returns to machining interface, machining continues.

3.9 Ruler storage function:

Function: In daily machining process, we often encounter such situations as power failure or machining couldn't be finished in one day. If losing the machining zero point, we have to retrieve the zero point of work piece which is troublesome. What's more serious is that there's always errors in retrieving the zero point of work piece by touching, which may cause errors to the parts machined afterwards. DRO provides ruler storage function. It stores the zero point of work piece by using the zero location of grating ruler, which enables the operator to find the zero point easily after power off without retrieving the zero point by touching.

Example: Take the X axis for example:

3. Basic functions

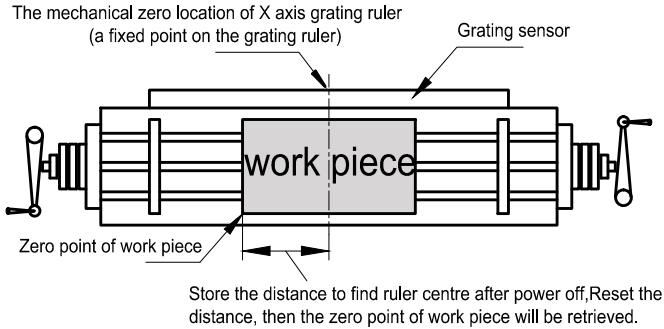

Note: The ruler storage function in our DRO is the most advanced and easiest to use in the DRO market. Each time the operator uses functions which may affect the zero point such as Zeroing, finding centre and inputting coordinate under ABS coordinate, DRO will store the distance between zero point of work piece and ruler centre. So the operator only need operate under the ABS coordinate to set the origin before either switching on the DRO or machining (the work piece hasn't been clamped onto the table). Through which the DRO will record the zero location of the ruler. Then DRO will deal with other storage processes without bothering the operator.

3.9.1 Ruler storage function (set the origin):

Function: When machining a complex work piece, its zero point couldn't lose under the cases of power off or failing to finish machining in one day. In this case we could set the origin under the ABS coordinate state of DRO to store the origin of the work piece into DRO. DRO will memorize the distance between the zero point of new work piece and ruler centre during all the operations of resetting the work piece's zero point under ABS coordinate such as Zeroing, finding centre and inputting coordinate so as to retrieve the work piece's zero point after power off or closing ruler.

Step 1: Enter REF function and select REF to set the origin.
(Find the grating ruler's origin)

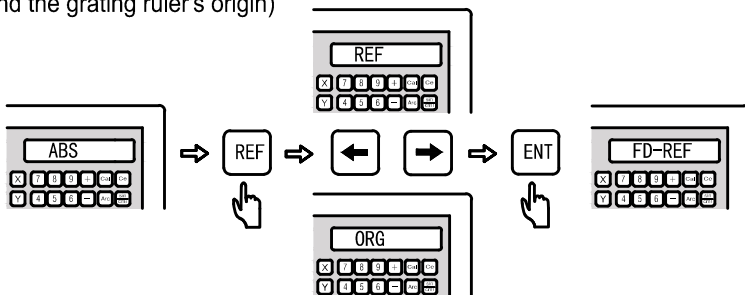

3. Basic functions

Note: Select REF for ruler storage function (find the grating ruler's zero location)
Select OGR for retrieving the work piece's coordinate origin (retrieve the work piece's coordinate origin)

Step 2: Select the axis of the ruler:

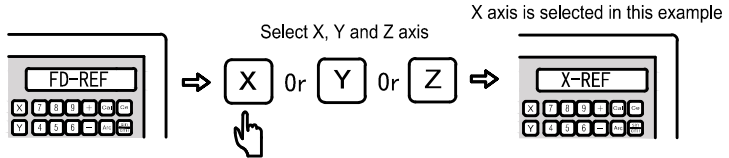

Step 3: Turn the hand wheel on X direction of the machine tool and move the table, then DRO will search for the machine zero point of grating ruler on X axis. When the machine zero point is fixed, the buzzer will ring once and the information window will promptly display: Find-X. Repeat step 2 and 3 to complete the ruler storage function of Y and Z axis.

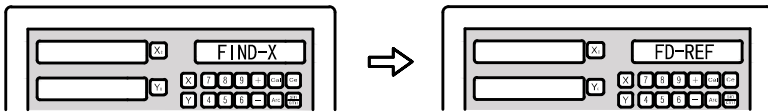

Turn the machine tool to find the grating ruler's zero location

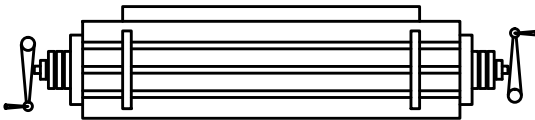

Step 4: Press  key to exit ruler search function and back to the machining interface.

3.9.2 Retrieve the work piece's origin:

Function: When machining a complex work piece, the zero point gets lost because of sudden power off. After the power is connected, we couldn't keep on machining until we retrieve the work piece's zero point. Note that we couldn't move the machine by this time. When DRO's self-checking finishes, press  key back to ABS coordinate (not necessary if DRO is already under ABS coordinate when switched on). By this time we need to record the data of X, Y and Z axis under the current ABS mode. Detailed operating steps are shown below.

3. Basic functions

Step 1: Record the data of X, Y and Z axis under ABS mode when DRO completes self-checking:

Example: If DRO completes switch-on self-checking under ABS mode X axis is 12.500 Y axis is 18.230 Z axis is 5.800 .

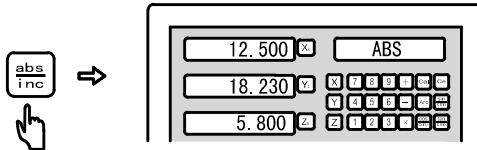

Note: DRO couldn't deal with the data of X, Y and Z axis automatically, so they need to be recorded to find the zero point.

Step 2: Enter REF function and select the function of retrieving the work piece's origin:

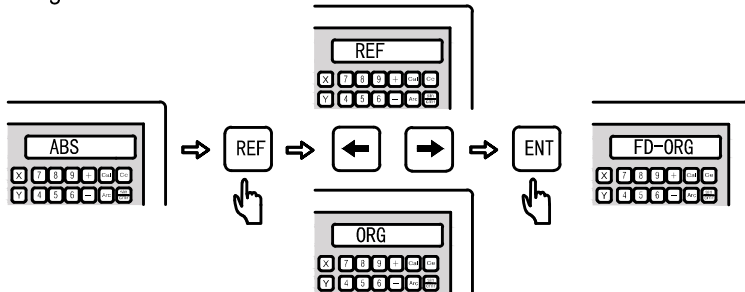

Note: Select REF for ruler storage function (find the grating ruler's zero location)
Select OGR for retrieving the work piece's coordinate origin (retrieve the work piece's coordinate origin)

Step 3: Turn the hand wheel on X direction of the machine and move the table, then DRO will find for the machine zero point of grating ruler on X axis. When the zero point is found, the buzzer will ring once and the information window will promptly display: Find-X. Repeat step 2 and 3 to complete retrieving the work piece's origin of Y and Z axis.

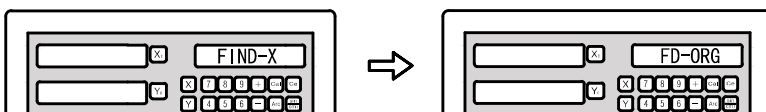

3. Basic functions

Turn the machine to find the grating ruler's zero location

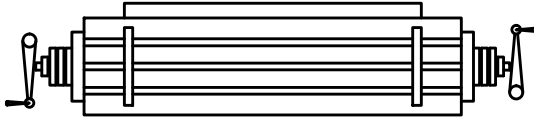

Step 4: After searching the work piece's origins on X, Y and Z axis, turn the machine under ABS coordinate state. When the coordinates of X, Y and Z axis are the ABS coordinates recorded at power-on self-checking, this point is the one when machining stopped at last power off and we could go on machining the unfinished work piece.

Example: Turn the machine to the coordinates recorded manually at power-on self-checking under ABS mode.

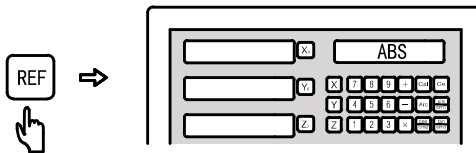

Turn the machine to retrieve the working point when machining stopped at last power off.

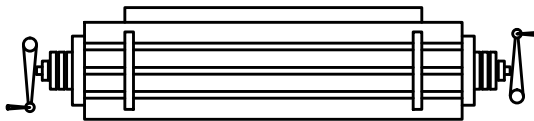

Press  key to exit the ruler tracking number function.

Note: Retrieve the work piece's origin. The data couldn't be recovered until the origin is set before machining.

3.10 Linear compensation

Function: Linear error compensation function is used to correct the system errors of the grating ruler measurement system linearly.

3. Basic functions

Note: the calculation formula of correction coefficient is:

$$\text{Correction coefficient } S = (L - L1) / (L / 1000) \text{ mm/m}$$

L: Stands for the actual measured length (mm)

L1: Stands for the displayed value (mm) on the DRO



S: Stands for correction coefficient (mm/m) (+ indicating lengthening and - indicating shortening)

Compensation range: - 1.9 mm/m to + 1.9 mm/m

Example: The actual length of the machine's X axis table is 1000.000mm and the displayed value on the DRO is 999.880mm. The correction coefficient is calculated as follows:

$$S = (1000.000 - 999.880) / (1000.000 / 1000.000) = 0.120$$

Set the linear compensation coefficient according to the following operation (Note: Set the compensation method as linear compensation in the system parameter setting section firstly. The detailed operations are described in system parameter setting section.)

Step 1: Press  key and then  key and the DRO will enter linear compensation setting.

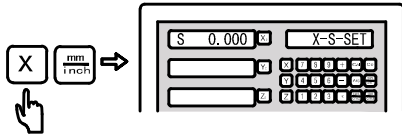

Step 2: Input the correction coefficient, then press  key and the linear compensation function will be prompted automatically.

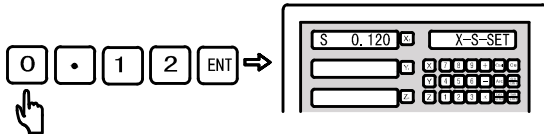

Note: The linear compensation operation of Y axis or Z axis resembles that of X axis.

3. Basic functions

3.11 Non linear compensation

Function:

Non linear compensation enables the operator to input non linear error compensation value in the DRO by which way the DRO could compensate all kinds of errors of the machine. Non linear compensation function of DRO could improve the accuracy of the machine greatly if only the positions of the machine have a high repeatability. This function is particularly applicable to the machine tools which have a high requirement on accuracy, such as grinding machine, boring machine etc.

Operating principles:

Non linear compensation adopts a fixed position provided by the REF position in the grating ruler as the absolute zero point of the machine. CPU of the DRO will compensate the readings according to the input error list in the parameter setting section. The software of the DRO could provide non linear error compensation function on X, Y and Z axis. Each axis has a maximum compensation value of 40 points. Note that non linear and linear compensation couldn't be used simultaneously.

This DRO has two methods for non linear error compensation:

- 1、Take the start point as the mechanical origin to make error compensation. (Figure 1)
- 2、Take the first absolute zero point of the grating ruler as the mechanical origin to make error compensation. (Figure 2)

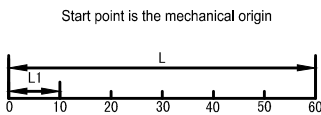

(Figure 1)

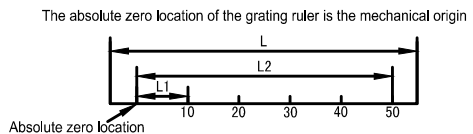

(Figure 2)

L: Distance of the grating ruler's effective range

L1: Length of the compensation part

L2: Effective distance of compensation

- 1、Parameters are set as follows: (The operation method for X, Y and Z axis is the same).

Step 1: Set the compensation method as non linear compensation in the system menu after booting. Press key and then key to select XYZ-CoMP. Then press , and keys to set X, Y and Z axis as non linear compensation. If X, Y and Z axis display Un-LinE respectively, it indicates that non linear compensation has been set. Press key again to exit system menu setting.

3. Basic functions

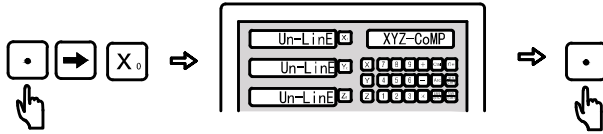

Step 2: Move the grating ruler to the minimum end of coordinate data for Zeroing. DRO enters the ABS absolute coordinate display method.

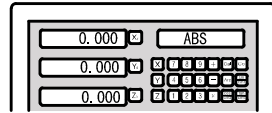

Step 3: Press \boxed{X} key and then $\boxed{\text{non-linear}}$ key to enter the non linear compensation function of X axis and input the relative parameters.

Step 4: Input the compensation part number

Set according to Figure 1:

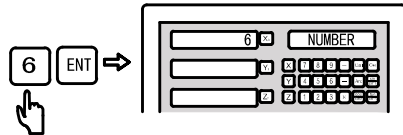

Set according to Figure 2:

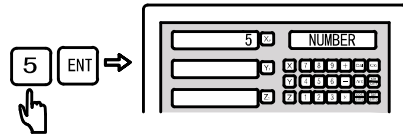

Note: The compensation part number of any axis should be inputted on X axis.

Step 5: Input the length of each compensation part

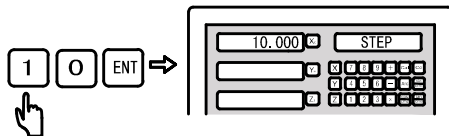

Step 6: Select the start point (non linear compensation takes the zero location as the start point. There are two kinds of zero location: a. the left zero, b. the mechanical zero location under ABS coordinates. Select by pressing $\boxed{\leftarrow}$ and $\boxed{\rightarrow}$ keys)

3. Basic functions

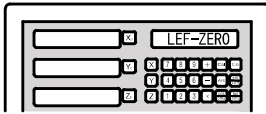

Method A: Zeroing at left

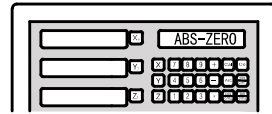
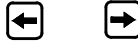

Method B: zero location under ABS coordinates

Method A (zeroing at left), clear the start point at the left and confirm by pressing key. Method B (ABS zero location), the operation is similar to finding the zero location under REF. It enters the compensation interface automatically after finding the zero location.

Zero location is a counting point and the most important reference point of non linear compensation. After entering the compensation interface, X axis displays the actual data of the grating ruler and Y axis displays the compensation value of the compensation axis.

Step 7: Input the adjusted values segmentally and press key to enter the next point.

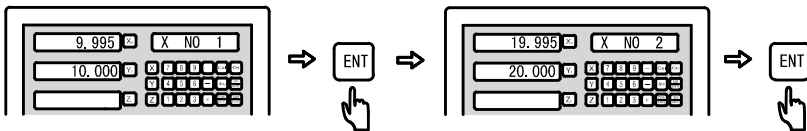

X axis displays the actual moving value of the grating ruler and Y axis displays the corrected value. When inputting the corrected value, we should measure from the start point to the displayed corrected value position of Y axis firstly and then move the X axis grating ruler to the measured standard value position.

Press key to set the next point.

Note: In this function the compensation range couldn't exceed 1mm/m, or the compensation is set as 0.

2. Method of cancelling non linear compensation value:

Non linear compensation value could only be used to the DRO, grating ruler and machine when they are set together. When a grating ruler or DRO whose compensation value has been set on a certain machine is moved to another machine, this non linear compensation value is incorrect. In this case we should cancel or reset the non linear compensation value.

3. Basic functions



The method of cancelling is:

According to the non linear compensation set method indicated above, input the compensation part as 0 when prompted to initialize all the compensation parameters. At present all the compensation parameters set before will be invalid and the current compensation value is zero.

3、 Method of retrieving the mechanical origin

When it was power off during grating ruler movement or grating ruler moved without power on, we have to find the mechanical origin again before booting. Because when the machine is moved under power off, the origin of the machine coordinate couldn't match the value on the DRO. If we don't retrieve the mechanical origin, such dislocation will be brought into the subsequent user coordinate system, as the non linear compensation value is set based on wrong mechanical coordinate when calculating the user coordinate, which brings errors to display coordinate.

Set the mechanical origin as follows:

Enter non linear compensation after booting. When inputting compensation part number and compensation length, make no change and press  key directly to skip. Then we come to select the compensation start point, select ABS-ZERO (ABS zero location) and press  key to find the zero location. At this time the information screen displays RESET-X, slide the X axis grating ruler to find the zero location until DRO gives out a sound. System has entered the compensation interface automatically then press  key to exit non linear compensation.

Note:

The work origin could only be retrieved when the start point of non linear compensation is set at the ABS zero location. If set the leftmost as the ABS zero location, the work origin couldn't be retrieved. At this time we have to reset the non linear compensation. The following method is recommended for setting non linear compensation: set the compensation start point as ABS zero location. The user searches the mechanical origin after each booting to guarantee the consistency of the mechanical origins.

3.12 200 sets of auxiliary zero location:

Function:

Typical grating DRO only provides two groups of coordinates, namely ABS/INC. But in most of the daily machining occasions, operators always find it not enough, especially in die machining or small batch machining. The DRO provides 200 sets of auxiliary zero location (SDM) function to compensate for the shortage of the ABS/INC function. But SDM is not just a simple additional INC coordinate, it has the following difference compared to ABS/INC.

3. Basic functions

1. INC zero location is completely independent. Regardless of any change in ABS zero location, INC zero location will never change. But the zero location of SDM is relative to ABS, which means when ABS zero location changes, all the SDM zero locations shall change correspondingly.
2. The distance of SDM relative to ABS coordinate could be entered by keys directly, which is both fast and precise.

Applications of SDM in sub zero point:

Operators could set each sub zero location on the work piece in the SDM auxiliary zero location coordinates.

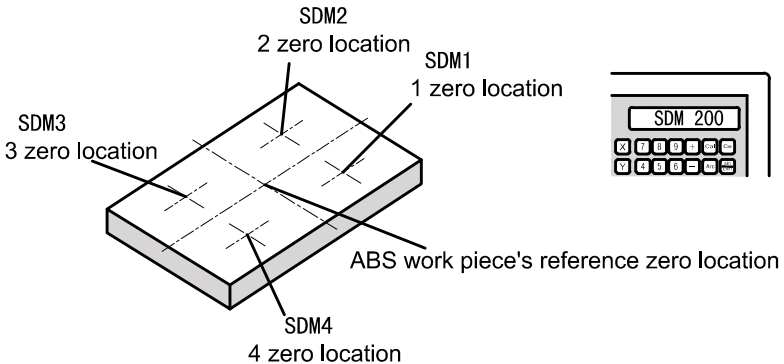

Press key or key to convert to SDM auxiliary zero location directly without returning to ABS coordinate.

Applications of SDM in small batch machining

SDM function could store batch of working point positions in SDM zero location. Operators could enter all the working points to the DRO at once. Alternatively, operators could also input the working points into SDM of DRO when machining the first work piece. Afterwards they only need to adjust the reference zero location of the subsequent work pieces in ABS coordinate. As the SDM zero locations correspond to these of ABS, all the working point shall recur by SDM zero locations.

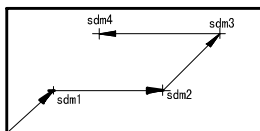

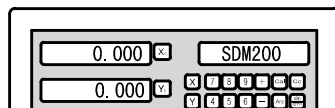

ABSzero

Reference of work piece (0.000)



3. Basic functions

Input the required coordinate value under SDM state according to SDM or press  and  keys to turn to each SDM auxiliary zero location. Move the machine until each SDM coordinate displays 0, which is the position of each working point.

SDM application examples:

If you need set 4 auxiliary zero locations on the work piece (from SDM1 to SDM4), two methods are available:

1. Zeroing in place.
2. Input each SDM coordinate by pressing keys directly.

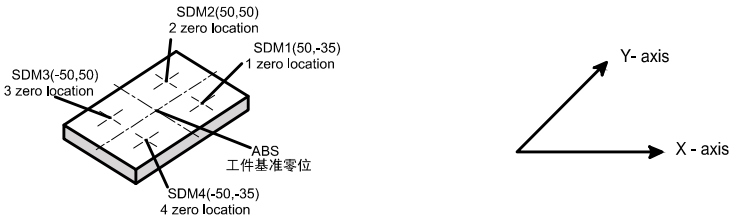

Method I: Zeroing in place

At first set the reference zero location of the work piece in ABS coordinate and move the table to each SDM zero location directly, then turn to SDM Zeroing and memorize the zero location.

Step 1: Set the reference zero location of the work piece in ABS coordinate

Move the table to reference zero location of the work piece

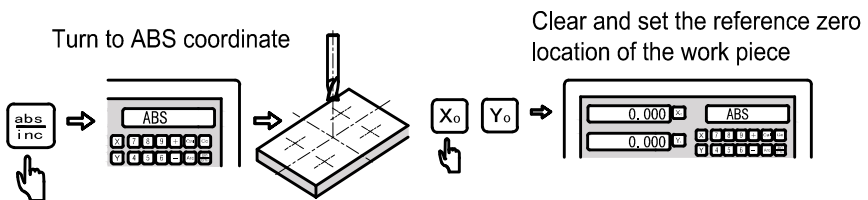

Step 2: Set the first zero location

Move the table of the machine to X=50.000, Y=-35.000 under ABS mode.

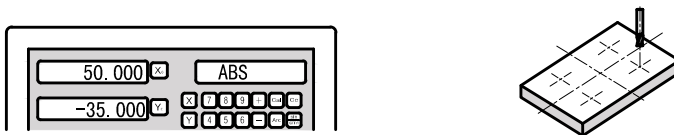

3. Basic functions

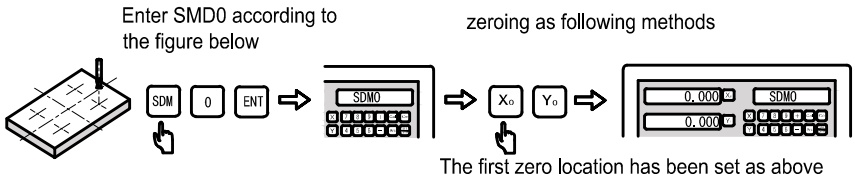

Step 3: Set the second zero location

Enter the ABS coordinate system according to the following operation. Move the table of the machine to fix the tool at the position of X=50.000, Y=50.000.

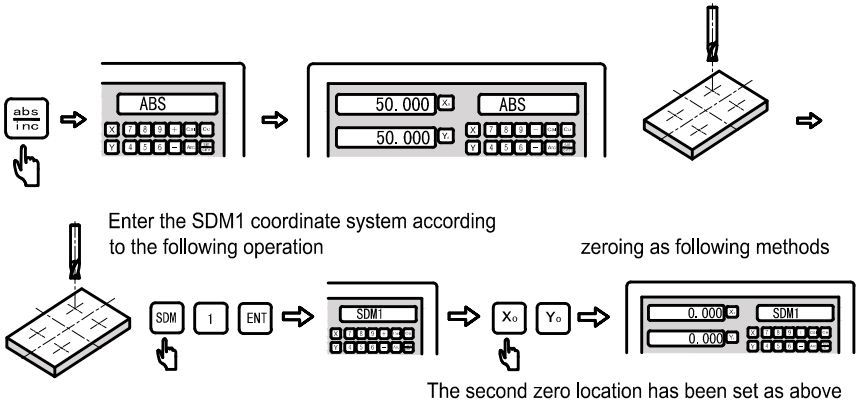

Step 4: Set the third zero location

Enter the ABS coordinate system according to the following operation. Move the table of the machine to fix the tool at the position of X=-50.000, Y=50.000 .

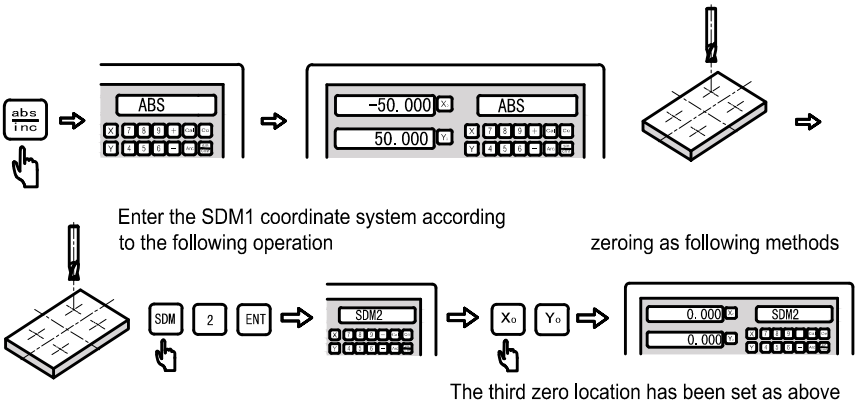

3. Basic functions

Step 5: Set the forth zero location

Enter the ABS coordinate system according to the following operation. Move the table of the machine to fix the tool at the position of $X=-50.000$, $Y=-35.000$.

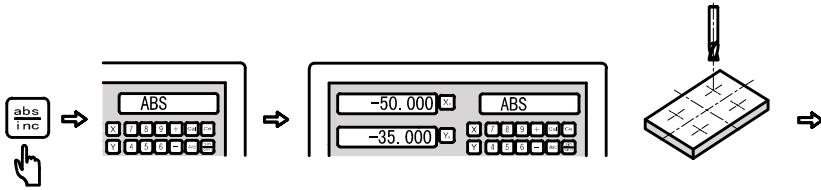

Enter the SDM1 coordinate system according to the following operation

zeroing as following methods

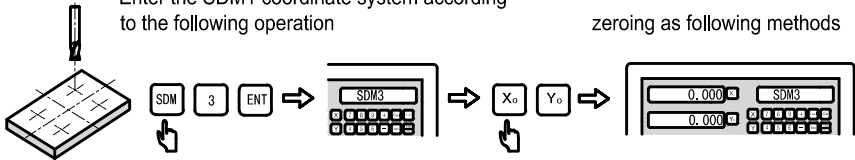

The forth zero location has been set as above

Press and keys to check whether the SDM coordinate inputted is correct. Checking operation as follows (check the coordinate of SDM3 origin under ABS, SDM0, SDM1, SDM2 and SDM3 coordinate systems.)

The present values of SDM3 origin correspond to ABS absolute coordinate system

Enter the ABS coordinate system according to the following operation

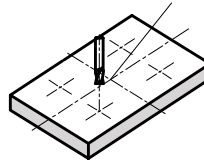
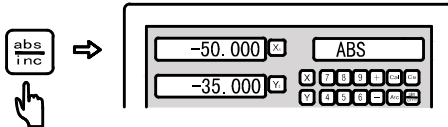

The present values of SDM3 origin correspond to SDM0 coordinate system

Enter the SDM0 coordinate system according to the following operation

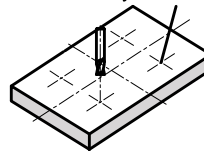
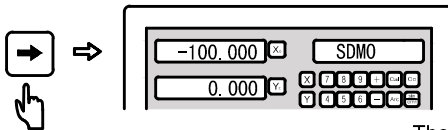

The present values of SDM3 origin correspond to SDM1 coordinate system

Enter the SDM1 coordinate system according to the following operation

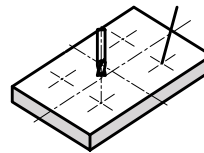
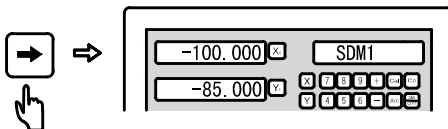

3. Basic functions

Enter the SDM2 coordinate system according to the following operation

The present values of SDM3 origin correspond to SDM2 coordinate system

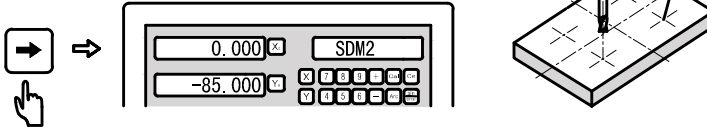

Zeroing in place is simple and clear, but lots of SDM zero locations have to be built up, which is inefficient, so method 2 is recommended.

Method 2: Enter SDM coordinate by pressing keys directly

The method of inputting SDM coordinate by pressing keys directly: At first set the reference zero location of the work piece in ABS coordinate and move the machine table to ABS zero point, then input all the SDM zero location coordinates in once at this position.

Step 1: Set the reference zero location of the work piece in ABS coordinate

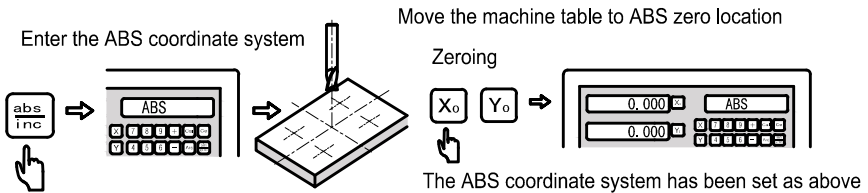

Step 2: Set the zero location of the first point

Invert the positive and negative number of SDM zero location coordinate of the first point, then input the coordinate

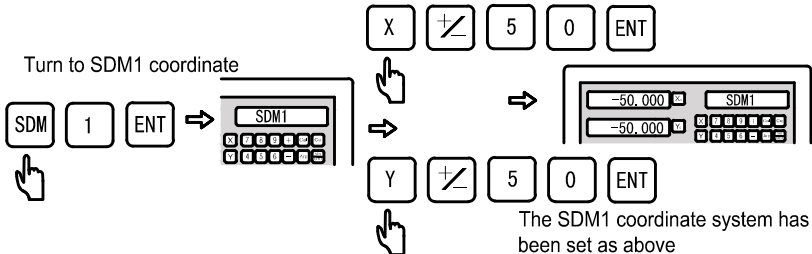

Note: When inputting all the SDM zero locations directly, we have to treat the coordinate values of the SDM zero location on the chart by positive and negative inversion. That's because the SDM zero coordinate on the chart takes ABS zero location as parameter, while in practice it takes SDM zero location as parameter. It is parallel to treat the ABS zero coordinate by different SDM zero locations.

3. Basic functions

Step 3: Set the zero location of the second point

Invert the positive and negative number of SDM zero location coordinate of the second point, then input the coordinate

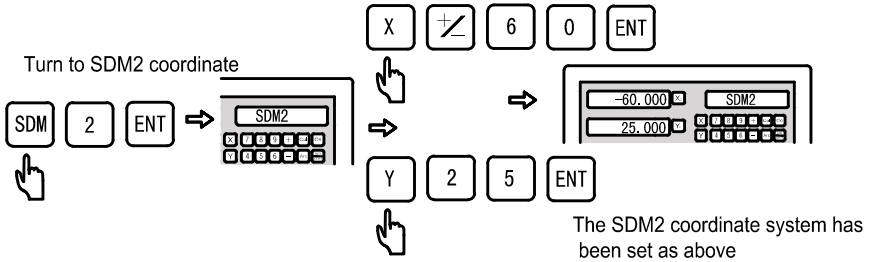

Step 4: Set the zero location of the third point

Invert the positive and negative number of SDM zero location coordinate of the third point, then input the coordinate

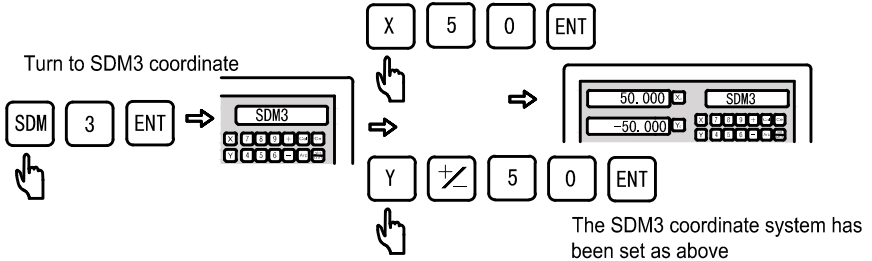



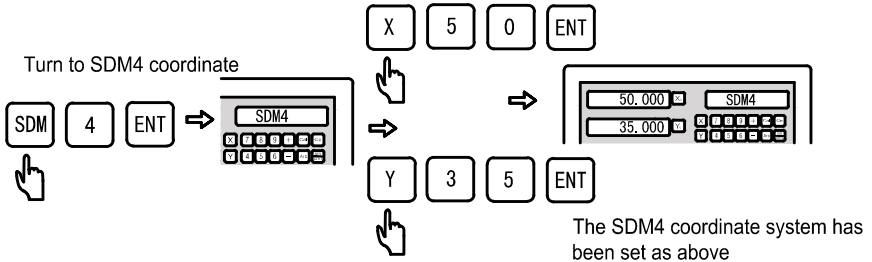

Step 5: Set the zero location of the fourth point

Invert the positive and negative number of SDM zero location coordinate of the fourth point, then input the coordinate



3. Basic functions

Note: Quick setup SDM coordinate

DRO provides 200 sets of coordinates from 0 to 199. It is inefficient to set by  and  keys. Under ABS or INC coordinate we have to press  key twice to set. But under SDM coordinate we only need to press  key once to set SDM coordinate, the detailed operation is as follows:

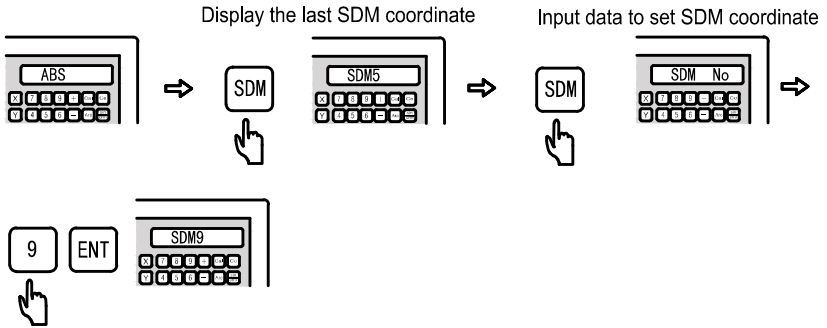

4. Special Function

PLD Function

4.1 PLD Function

4.1 PLD Function

(Applicable to the machine tools: 2M, 3M milling machines and Electric Discharge Machines)

We have two ways to realize the PLD function.

Way 1: Length way (L-LEN, the distance from the starting hole center to the ending hole center)

Way 2: Step way (L-STEP, the distance between two adjacent holes)

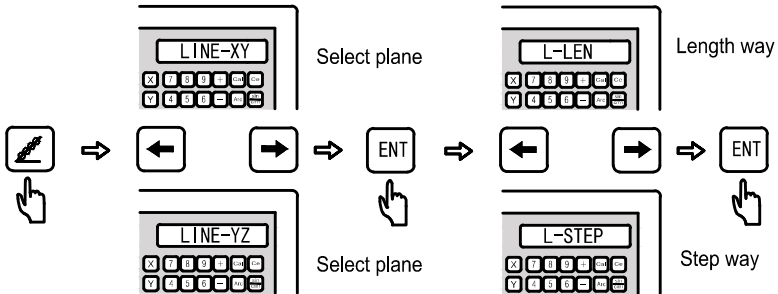

PLD input parameters:

L-LEN:

LENGTH -- oblique line overall length (the distance from the starting hole to the ending hole, as shown in figure B)

ANGLE -- oblique line angle (as shown in figure A)

No HOLE -- hole number (as shown in figure B)

L-STEP:

STEP ---- pitch-row length (the distance between two adjacent hole centers, as shown in figure B)

ANGLE -- oblique line angle (as shown in figure A)

No HOLE -- hole number (as shown in figure B)

Example: as shown in the right figure

Figure A:

The angle refers to the position direction of the oblique line on the coordinate plane. The anti-clockwise direction is the positive direction, and the clockwise direction is the negative direction.

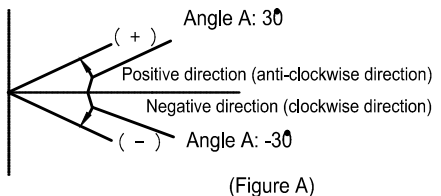

(Figure A)

4.1 PLD Function

Figure B:

oblique line: 60mm
 oblique line angle: 30mm
 pitch-row: 20mm
 holes: 4

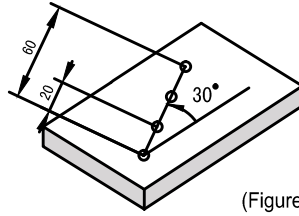



(Figure B)

Example 1: L-LEN

Step 1: Firstly, move the tool to the position of the starting hole. (L-LEN)



Press the  key to enter the function of punching on an oblique line.

Step 2: Select the machining plane

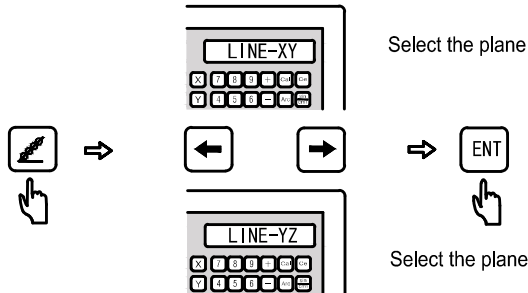
Press the  and  keys to select the “machining plane” and press the  key for confirmation (This setting is only available for 3 M and EDM DRO. Because 2M DRO only contains XY plane, it can jump into the next step directly without selection).



Step 3: Machining way selection

Press the  and  keys to select “the machining way” and press the  key for confirmation. Here, we select the L-LEN.

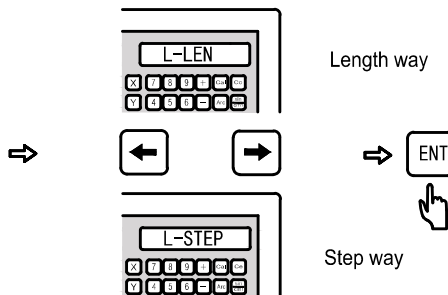

4.1 PLD Function

Step 4: Input length

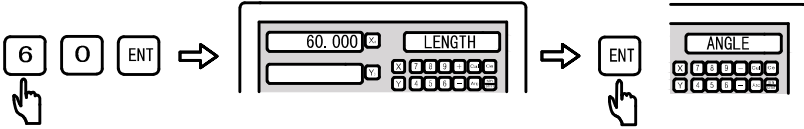

Step 5: Input angle

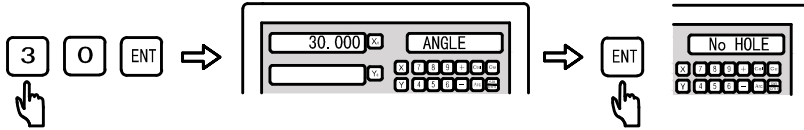

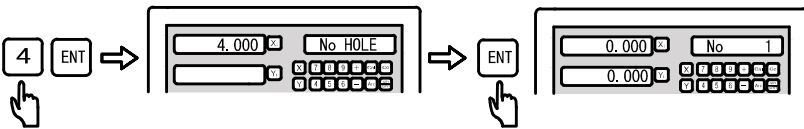

Step 6: Input hole number

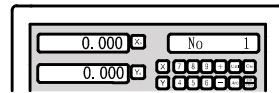

Step 7: Enter the machining state, and display the position of the first hole





Step 8: Press the  key to display the position of the next machining point, then move the machine tool until the axis displays zero, indicating the position of the second machining point, and press the  key to exit the function of punching on an oblique line anytime.

Example 2: L-STEP

Step 1: Firstly, move the tool to the position of the starting hole. (L-STEP)
Press the  key to enter the function of punching on an oblique line.

Step 2: Select the machining plane

Press the  and  keys to select the “machining plane” and press the  key for confirmation (This setting is only available for 3 M and EDM DRO. Because 2M DRO only contains XY plane, it can jump into the next step directly without selection).

4.1 PLD Function

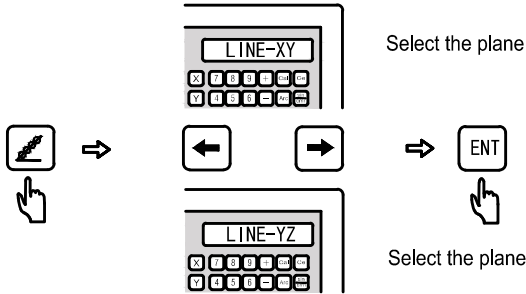

Step 3: Machining way selection

Press the and keys to select “the machining way” and press the key for confirmation. Here, we select the L-STEP.

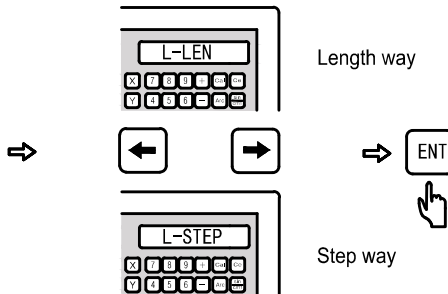

Step 4: Input step length

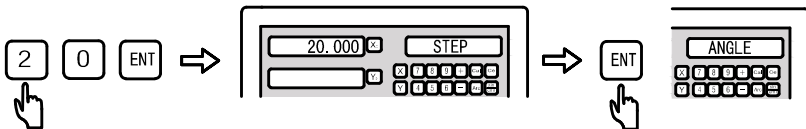

Step 5: Input angle

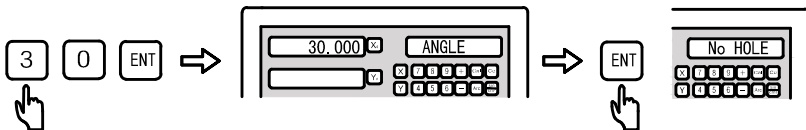

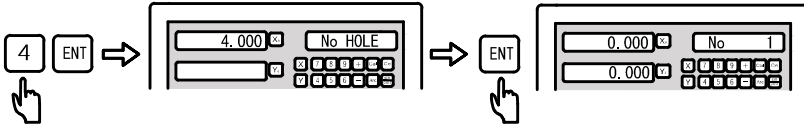

Step 6: Input hole number

4.1 PLD Function

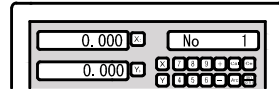

Step 7: Enter the machining state, and display the position of the first hole



Step 8: Press the  key to display the position of the next machining point, then move the machine tool until the axis displays zero, indicating the position of the second machining point, and press the  key to exit the function of punching on an oblique line anytime.

PCD Function

4.2 PCD Function

4.2: PCD Function

(Applicable to machine tools: 2M and 3M milling machines and EDM)

This function is used for dividing the arc equally, such as the equally distributed holes on the drilling flange.

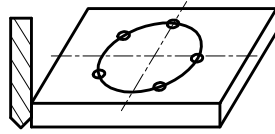



Function:

The DRO offers the tool positioning function of drilling equally divided holes on the circumference. Operators only need to input the relevant machining parameters according to the provided information, then the system will calculate the position coordinates of holes immediately and set the hole position to zero point (0.000, 0.000) temporarily. Operators only need to input the following six parameters.

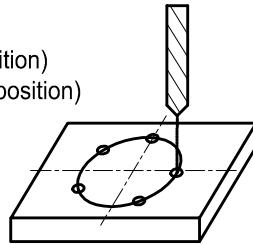
- | | |
|---------|--|
| PCD-XY | plane selection |
| CT-POS | circle center coordinate |
| DIA | arc diameter |
| ST-ANG | starting angle (angle of 1st hole position) |
| ED-ANG | ending angle (angle of the last hole position) |
| No HOLE | hole number |



The DRO automatically calculates the position of every equally divided hole on the circumference and sets position of every hole to zero point. Operators only need to press the  and  keys to select which hole to be reached on the circumference, then move the machine tool until the DRO displays (0.000), i.e. the hole position is reached.

Note: The angle direction is shown in the right figure.

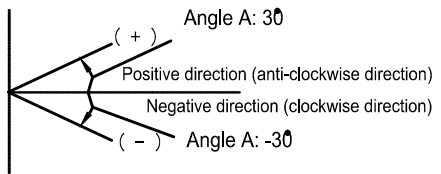

(Figure A)

Example: Machining for the Work Pieces as shown in the Figure

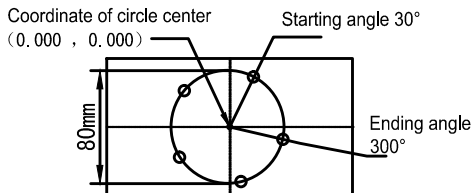

- PCD-XY -- plane XY
- CT-POS --- coordinate of circle center X=0.000 Y=0.000
- DIA ----- 80mm arc diameter
- ST-ANG --- starting angle 30°
- ED-ANG --- ending angle 300°
- No HOLE -- 5 holes



4.2 PCD Function

Step 1: Find the central position of the work piece, and Set the tool.
Press the  key to enter the PCD function.

Step 2: Plane selection

Press the  and  keys to select the machining plane to select XY plane and then press the  key to confirm the next step.

This setting is only available for 3M and EDM DRO. Because 2M DRO only contains XY plane, it can jump into the next step directly without selection.

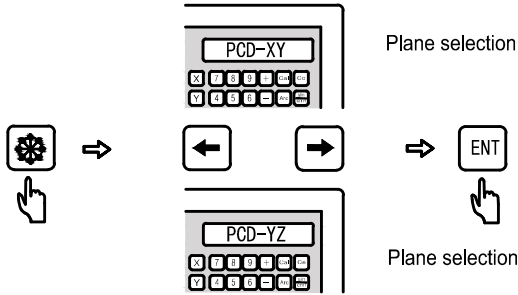

Step 3: Enter coordinate of circle center

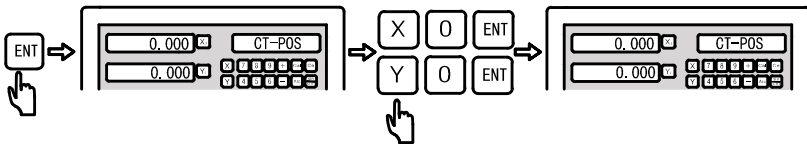

Step 4: Input diameter

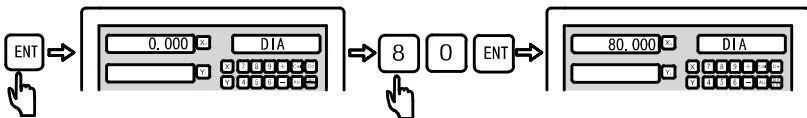

Step 5: Input starting angle

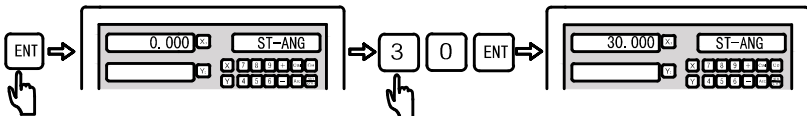

Step 6: Input ending angle

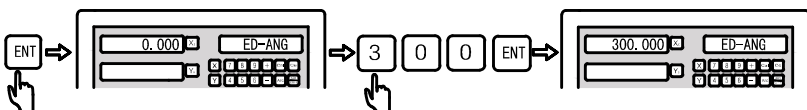

4.2 PCD Function

Step 7: Input hole number

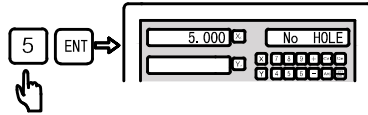

Step 8: Enter the machining state

Enter the machining state, and display the position of the first hole.

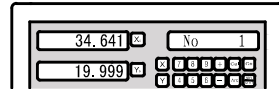

Step 9: Move the machine tool until the axis displays zero, i.e. the first point position is reached. Press the  key to display next machining point position, and move the machine tool until the axis displays zero.

Step 10: Press the  key to exit the PCD function anytime.

Smooth R Function

4.3 Smooth R Function

4.3 Smooth R function

(For 2M and 3M Digital Readout (DRO))

Function:

When a milling machine is used, especially in the process of machining a mold, arc often needs to be machined on a work piece. If the arc surface is complex, or a lot of round angles need to be machined, or the arc or round angle needs to be accurately machined, a CNC milling machine should be utilized.

But in the daily machining process, only a simple arc surface or a round angle is needed with no requirements for the precision of the arc or round angle (particularly in the process of machining molds). If there is no CNC milling machine in the production line, the best way is to machine it with a manual milling machine as it saves time and efforts, compared to outsourcing it. In the past, an operator used to calculate the tool positioning in arc machining with a scientific calculator, but this method was time-consuming and liable for errors.

DRO provides a simple and easy positioning function for arc cutting tool, so the operator can perform arc machining in the shortest time. But before you decide to use smooth R function or CNC machining, please bear the following points in mind to make sure smooth R yields the best performance.

The R function group in DRO contains two R functions: smooth R function and simple R function.

Smooth R function:

Smooth R function is a function for full-functional arc machining. The operator can use the smooth R function to machine all types of most complex arc, even an arc to be connected to another arc (commonly known as R-to-R).

Advantages of smooth R function:

Smooth R function can be used to machine the most complex arc or even for complex machining in R-to-R.

Disadvantages of smooth R function:

Operation is complex and the operator needs to know the basic coordinate system in order to calculate the start point, the end point and the center.

Simple R function:

As most arcs machined with a manual milling machine are very simple, and the operator may machine just one or two simple arcs with the manual milling machine in a month, DRO provides simple R function so that arc machining can be done in a simple and straightforward way without any calculation.

Disadvantages of simple R function:

Simple R function can only machine eight types of common arcs, and cannot machine relatively complex types of arc.

4.3 Smooth R Function

Select smooth R or simple R:

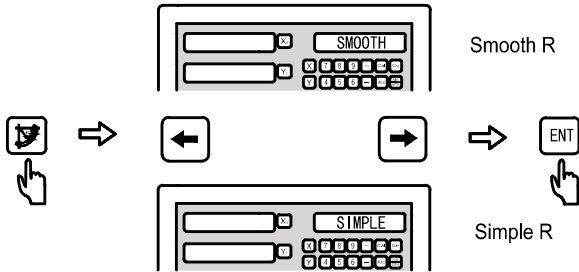

Understand the coordinate system:

An operator who has no CNC programming experience or who has not used the DRO R function before may have difficulty in mastering the concept of coordinate system. Coordinates are a pair of numbers used to determine positions.

When using the DRO R function, the center coordinates of the arc surface, and the coordinates of the start point and those of the end point must be input to inform DRO about the geometric parameters of the arc surface to be machined.

In the process of installing a DRO, professional customer service installers will generally set the display orientation in the same direction as the machine axis. In a general milling machine, the dial direction is shown as below. Therefore, the DRO display direction will normally be set as follows.

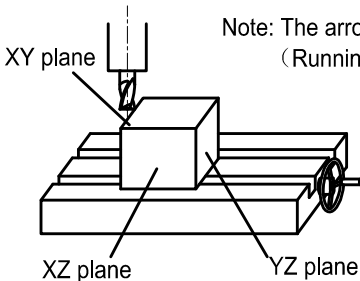

Note: The arrow indicates the positive direction of the coordinate (Running direction of the tool relative to the table)

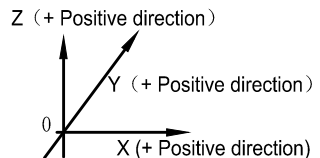

What are coordinates?

Coordinates are used to indicate positions. During plane machining, each set of coordinates contains two values, respectively corresponding to the distances from the zero point on the plane. The following is a simple example.

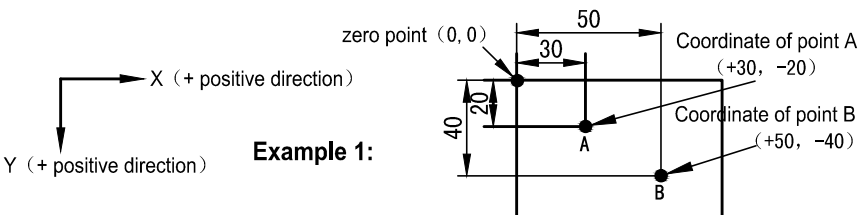

4.3 Smooth R Function

Example 2:

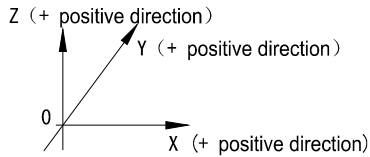
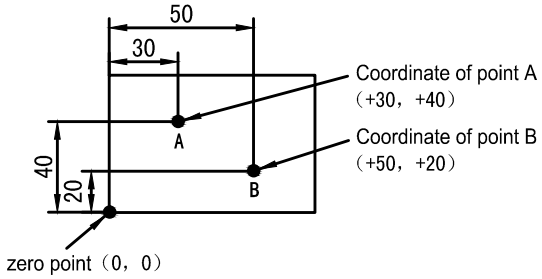

Example 3:

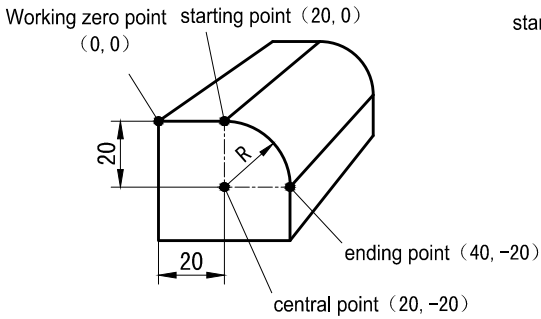

Example 4:

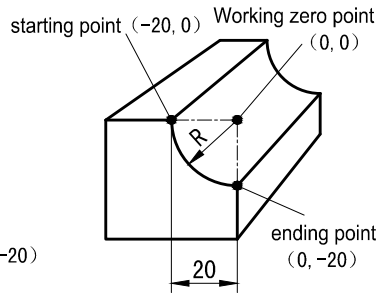

During the machining process, the coordinate of the machine tool are shown in the figure below, and the indication of the machining plane is shown in the figure.

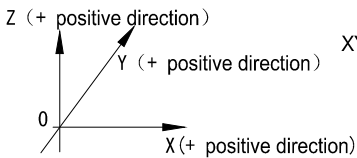

XY arc plane

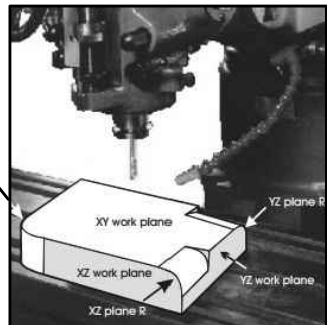

4.3 Smooth R Function

The definition of the angle and direction:

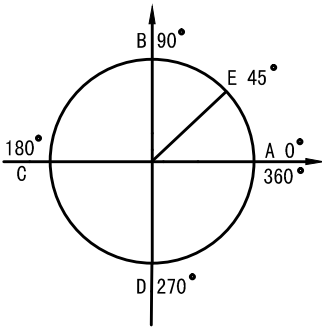

- AB arc (from A to B: the starting angle A is 0°, and the ending angle B is 90°)
 (from B to A: the starting angle B is 90°, and the ending angle A is 0°)
- ED arc (from E to D: the starting angle E is 45°, and the ending angle D is 270°)
 (from D to E: the starting angle D is 270°, and the ending angle E is 45°)

Smooth "R" Arc Function:

Procedure for using the smooth arc machining function:

Load and clamp the work piece, tool setting as shown in figure A, figure B and figure C, and then zero every axis (set the position point of the tool setting to zero).

Step 1: Press the  key to enter the smooth R arc function.

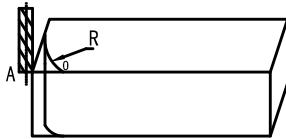



Figure A

Step 2: Press the  and  keys to select the smooth R arc function. If the information box displays SMOOTH, it indicates the smooth R function; if it displays SIMPLE, it indicates the simple R function.

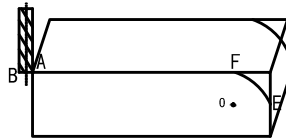

Figure B

Step 3: Select the machining plane XY, XZ, YZ where the arc surface is located (ARC-XY, ARC-XZ, ARC-YZ). 2-axis DRO only contains XY plane.

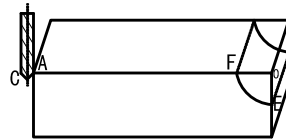

Figure C

Step 4: Input the coordinate of circle center position (CT-POS). The arc center position refers to the position of the arc center relative to the tool when zeroing the tool setting. As shown in figure B, the flat end milling cutter used in machining XZ, YZ planes refers to the position of arc center point O relative to tool point B. As shown in figure C, the used arc milling cutter refers to the position of arc center point O relative to the tool point C.

Step 5: Input the arc radius R.



4.3 Smooth R Function

Step 6: Input the TL-DIA: perform the machining for arcs on XZ and YZ planes. Note: As shown in figure B, use the flat end milling cutter to machine R. The tool machining point is point B, and the TL-DIA does not affect the machining. Please input the TL-DIA = 0.

Step 7: Input the maximum cutting amount (MAX-CUT). For this function of machining arc, the cutting amount of every tool is equal.

Step 8: Input the ST-ANG of the arc, The position of the first tool for machining R arc is shown in figure B. If the arc is machined from point E to point F, the starting angle is 0° ; if from point F to point E, the ending angle is 90° .

Step 9: Input the ED-ANG of the arc, The position of the last tool for machining R arc is shown in figure B. If the arc is machined from point E to point F, the starting angle is 90° ; if from point F to point E, the ending angle is 0° .

Step 10: Determine the machining plane of the arc (RAD-RL concave)(RAD+RL convex) The convex machining of arc plane is shown in figure B, and the concave machining of arc plane is shown in figure C. Press the  and  keys to select the convex machining or concave machining.

Step 11: Move the machine tool to the machining starting point according to the axis display, and then machine the arc point by point.

Step 12: Press the  key to exit the arc function anytime.

Example 1: Take the arc shown in the machining drawing as example:

The work piece size are shown in the figure below

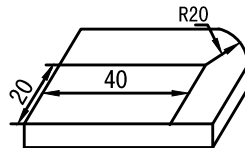

1. Zero the tool setting
2. Select smooth R mode (SMOOTH)
3. Select XY plane for machining arc (ARC-XY)
4. Input the coordinate of circle center
CT-POS = (43.23)
5. Input the arc radius $R = 20.000$
6. Input the TL-DIA = 6.000
7. Input the MAX-CUT = 0.3
8. Input the ST-ANG = 0
9. Input the ED-ANG = 90
10. Input the arc machining plane RAD+RL
(Select the convex to machine)

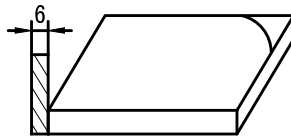

(Figure A)

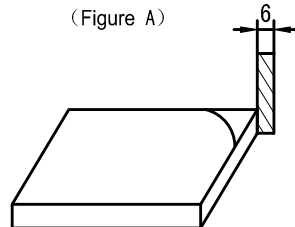

(Figure B)

4.3 Smooth R Function

The following is the operation figure for selecting smooth R arc machining.

Step 1: Zero the tool setting

Step 2: Press the  key to enter arc R function, And select smooth R arc function.

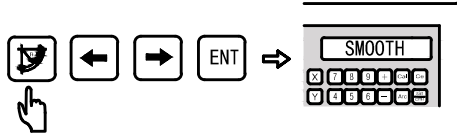

Step 3: Select XY plane for machining (ARC-XY). 2-axis DROs only contain XY plane.

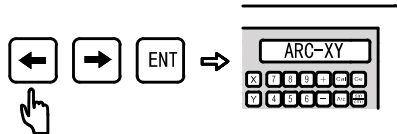

Step 4: Input the coordinate of circle center

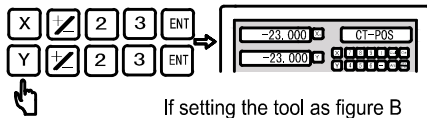
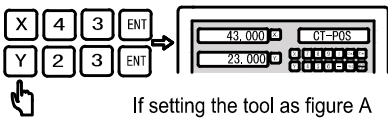

Step 5: Input the arc radius

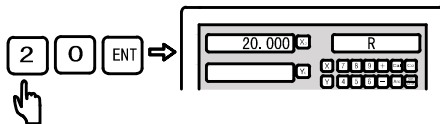

Step 6: Input the TL-DIA

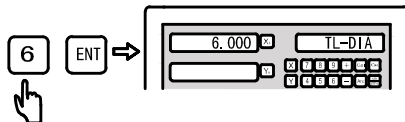

Step 7: Input the MAX-CUT

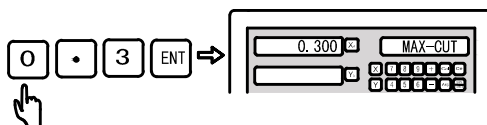

4.3 Smooth R Function

Step 8: Input the ST-ANG

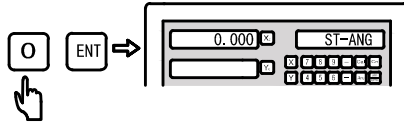

Step 9: Input the ED-ANG

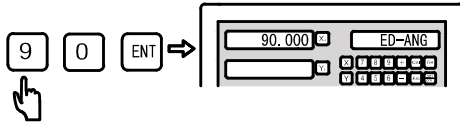

Step10: Select the convex as the machining plane

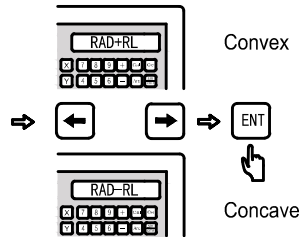

Step11: Enter machining and display the first point position

If setting the tool as figure A, the display is

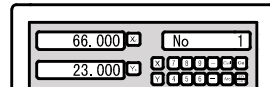

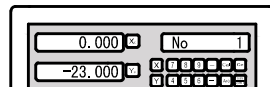

If setting the tool as figure B, the display is

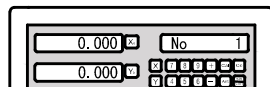

Step12: Move the machine tool until the axis display is zero, i.e. the R starting point



4.3 Smooth R Function

Step13: Press the  and  keys to display the position of each machining point, and move the machine tool until the axis display is zero, i.e. the position of each point of R arc.

Step 14: Press the  key to exit arc R function at anytime

Example 2: Take machining the following arc as example:

The work piece size are shown in the figure below

1. Zero the tool setting
2. Select smooth R mode (SMOOTH)
3. Select XY plane for machining arc (ARC- XZ)
4. Input the coordinate of circle center CT-POS = (33,-3)
5. Input the arc radius R = 10,000
6. Input the TL-DIA = 6.000
7. Input the MAX-CUT = 0.3
8. Input the ST-ANG = 27 0
9. Input the ED-ANG= 180
10. Input the arc machining plane RAD-RL (Select the concave to machine)

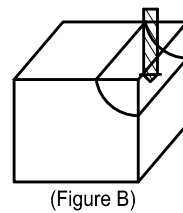
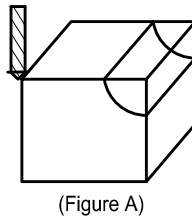
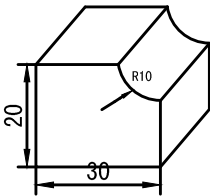

Step 1: Zero the tool setting

Step 2: Press the  key to enter arc R function And select smooth R arc function.

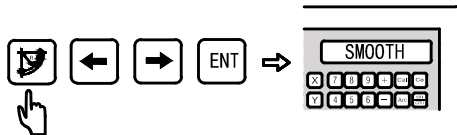

Step 3: Select XZ plane for machining (ARC- XZ),2-axis DROs only contain XY plane.

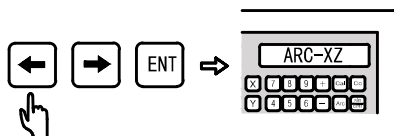

4.3 Smooth R Function

Step 4: Input the coordinate of circle center

If you use the arc milling cutter, set the tool as figure A

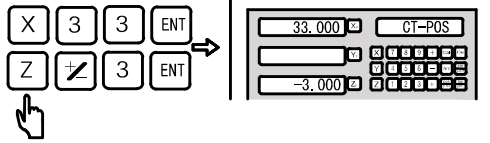

If you use the arc milling cutter, set the tool as figure B

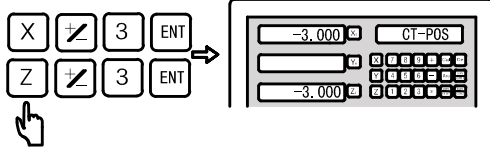

If you use the flat end milling cutter, set the tool as figure A

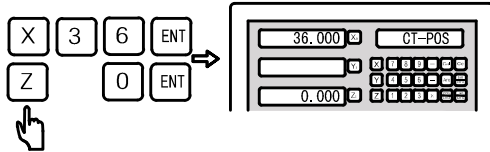

If you use the flat end milling cutter, set the tool as figure B

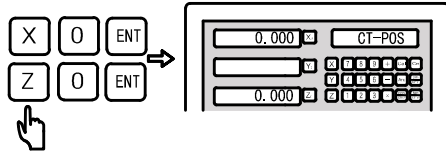

Step 5: Input the arc radius

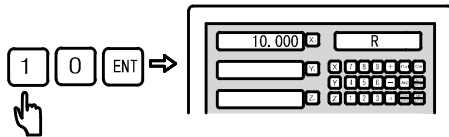

Step 6: Input the TL-DIA

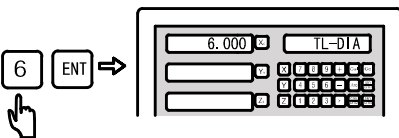

Use the arc milling cutter

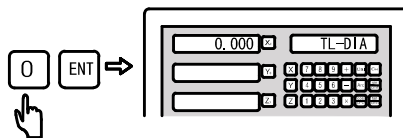

Use the flat end milling cutter

4.3 Smooth R Function

Step 7: Input the MAX-CUT

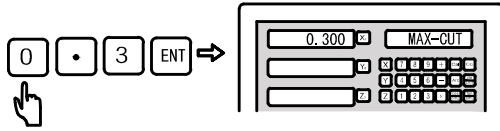

Step 8: Input the ST-ANG

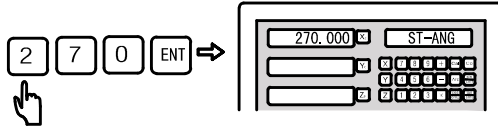

Step 9: Input the ED-ANG

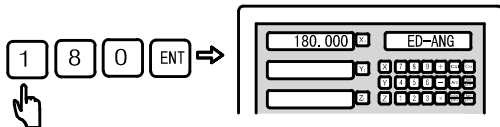

Step10: Select the concave as the machining plane

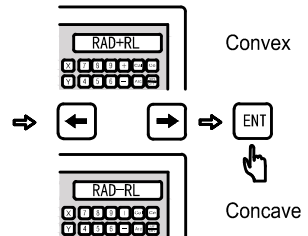

Step11: Enter machining and display the first point position

If you use the arc milling cutter and set the tool as figure (A), it will display:

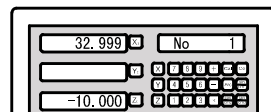

If you use the arc milling cutter and set the tool as figure (B), it will display:

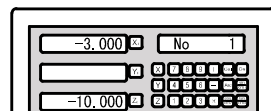

4.3 Smooth R Function

If you use the flat end milling cutter and set the tool as figure (A) , it will display:

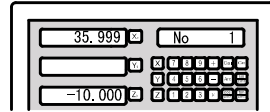

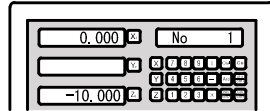

If you use the flat end milling cutter and set the tool as figure (B), it will display:

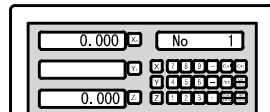

Step12: Move the machine tool until the axis display is zero, i.e. the R starting point



Step13: Press the  and  keys to display the position of each machining point, and move the machine tool until the axis display is zero, i.e. the position of each point of R arc.

Step 14: Press the  key to exit arc R function at anytime

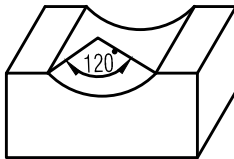

(C)

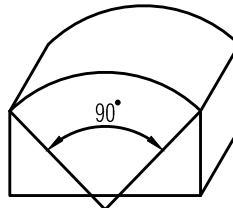

(D)

Note: On XZ and YZ planes, machining passing the arc at 90° and 270° positions is shown in figure (C); the machining for the arc from 210° to 330° (passing 270°) is shown in figure (D); when the arc passes from 135° to 45° (passing 90°), do not use the flat end milling cutter for the machining.

4.3 Smooth R Function

Example 3: Take machining the following arc as example:

The work piece size is shown in the figure below

1. Zero the tool setting
2. Select smooth R mode (SMOOTH)
3. Select XY plane for machining arc (ARC- XZ)
4. Input the coordinate of circle center CT-POS = (14.11)
5. Input the arc radius R = 10.000
6. Input the TL-DIA = 6.000
7. Input the MAX-CUT = 0.3
8. Input the ST-ANG= 30
9. Input the ED-ANG= 150
10. Input the arc machining plane RAD+RL (Select the convex to machine)

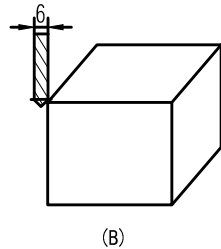
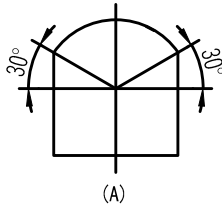
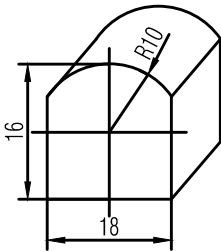

Step 1: Zero the tool setting

Step 2: Press the  key to enter arc R function And select smooth R arc function

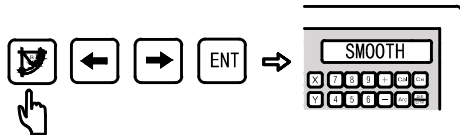

Step 3: Select XZ plane for machining (ARC- XZ)
2-axis DROs only contain XY plane.

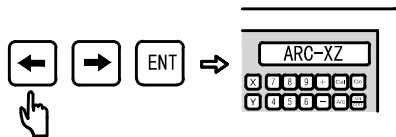

4.3 Smooth R Function

Step 4: Input the coordinate of circle center

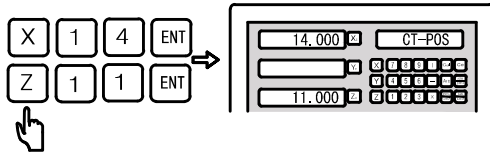

Step 5: Input the arc radius

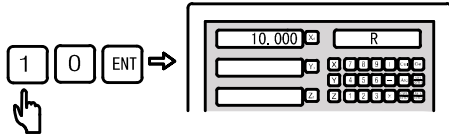

Step 6: Input the TL-DIA

Now use the arc milling cutter, set the tool as figure (B).

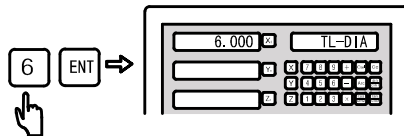

Step 7: Input the MAX-CUT

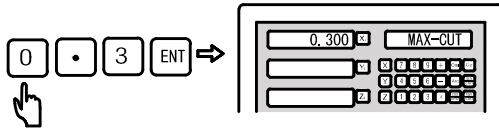

Step 8: Input the ST-ANG

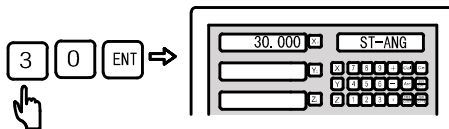

Step 9: Input the ED-ANG

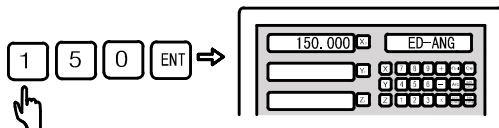

4.3 Smooth R Function

Step10: Select the convex as the machining plane

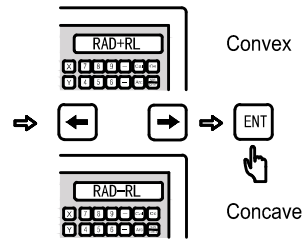

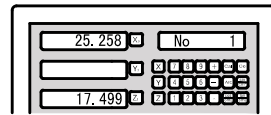

Step11: Enter machining and display the first point position

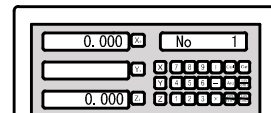

Step12: Move the machine tool until the axis display is zero, i.e. the R starting point



Step13: Press the  and  keys to display the position of each machining point, and move the machine tool until the axis display is zero, i.e. the position of each point of R arc.

Step 14: Press the  key to exit arc R function at anytime

Simple R function

4.4 Simple R function

4.4: Procedures for using simple R function (Applicable to: 2M and 3M DROs)

Function:

If you are not familiar with the concept of plane coordinate, you may have difficulty of using the smooth R arc function. If very simple arcs are needed for machining and there is no high requirement for the smoothness, the simple R arc calculation function can be used at this moment. Generally, the arc machining mainly includes the following 8 types, and the flat end milling cutter or arc milling cutter is used for the machining.

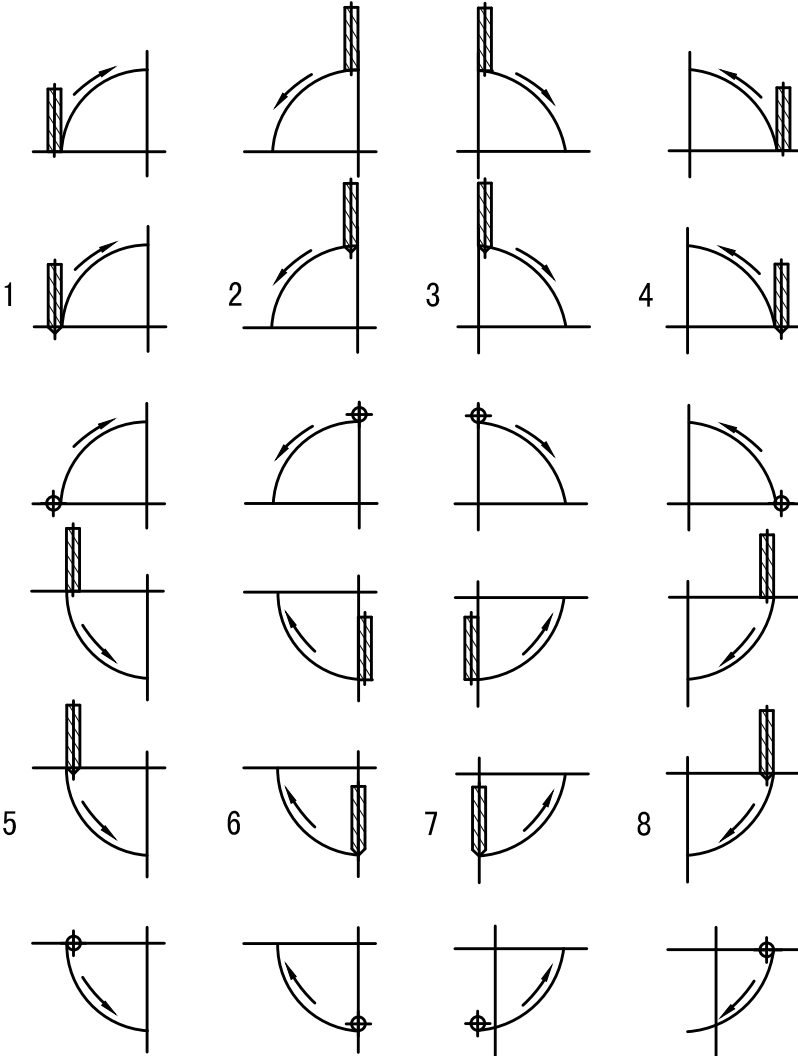

4.4 Simple R function

Procedure for using simple R function:

Place the tool directly opposite to the starting point of the arc, and press the  key to enter R arc calculation function. Please refer to figure (1) for the method to place the tool directly opposite to the starting point of the arc.

Step 1: Select the simple R function (SIMPLE).

Step 2: Select R machining type which is one of the pre-set type 1-8, and the indicated type is type 1-8.

Step 3: Select XY, XZ and YZ plane for machining (ARC-XY, ARC-XZ, ARC-YZ).

Step 4: Input the arc radius

Step 5: Input the TL-DIA: when machining the arc on XZ and YZ planes, please machine with the tool angle end of flat end milling cutter and set the TL-DIA to 0. (You may refer to step 6 in the procedures for using the smooth R function).

Step 6: Input the MAX-CUT:

In machining the arcs on XZ and YZ planes, "MAX-CUT" in the simple R function refers to the amount of feed for every step as shown in figure (A). The MAX-CUT

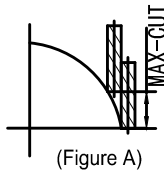

(Figure A)

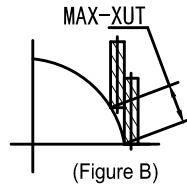

(Figure B)

can be changed during the machining process. When machining the arc on XY plane, "MAX-CUT" refers to the cutting amount of every tool. As shown in figure (B), the cutting amount for every tool is equal.

Step 7: Select the convex or concave as the machining plane.



Step 8: Machine the arc according to the display point by point.

Step 9: Press the  key to exit R arc calculation function anytime.

Example 1: Take machining the arc shown in the figure as example:



4.4 Simple R function

Step 1: Place the tool directly opposite to the starting point (A or B) of the arc, then press the  key to enter ARC function. Select the simple R function, and press the  key for confirmation.

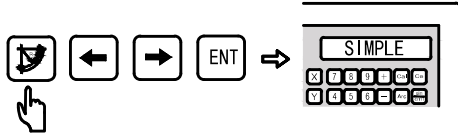

Step 2: Select R machining type

The starting point is A

3

ENT

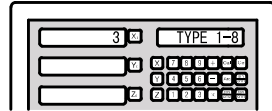

The starting point is B

4

ENT

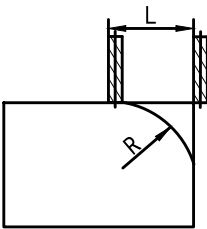
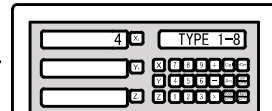

$$L = R$$

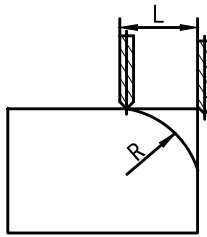

$$L = R + \text{tool radius}$$

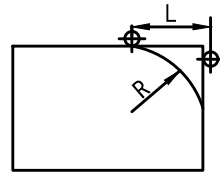

$$L = R + \text{tool radius}$$

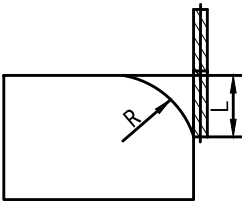

$$L = R$$

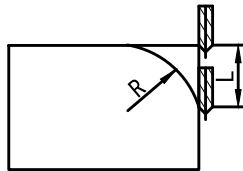

$$L1 = R + \text{tool radius}$$

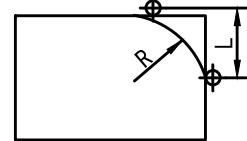

$$L1 = R + \text{tool radius}$$

4.4 Simple R function

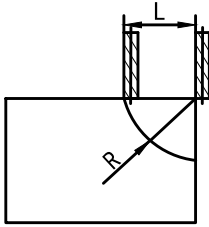

$$L=R$$

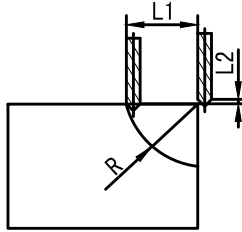

$$L1=R$$

$$L2 = R + \text{tool radius}$$

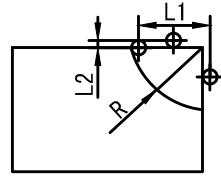

$$L1=R$$

$$L2 = R + \text{tool radius}$$

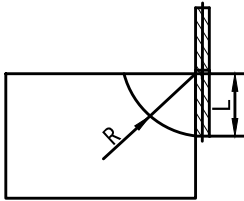

$$L = R$$

Flat end milling cutter

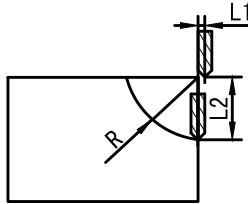

$$L1 = R + \text{tool radius}$$

$$L2=R$$

Arc milling cutter

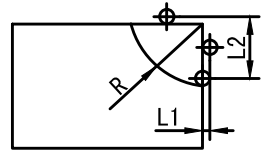

$$L1 = R + \text{tool radius}$$

$$L2=R$$

XY plane

Step 3: Select XZ plane for machining

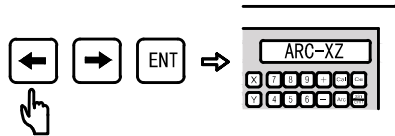

Step 4: Input the arc radius R

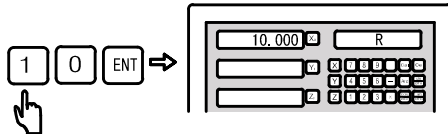

4.4 Simple R function

Step 5: Input the TL-DIA

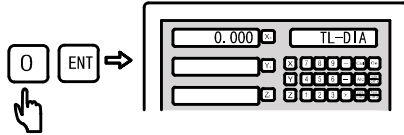

Step 6: Input the MAX-CUT

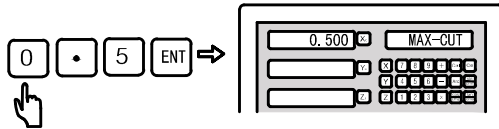

Step 7: Select the convex as the machining plane

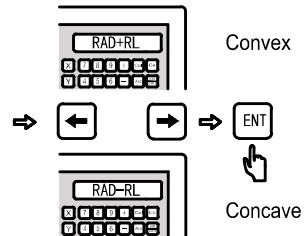

Step 8: Enter machining point

Take A as the starting point (0, 0)

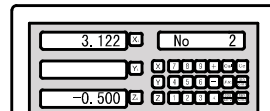

Take B as the starting point (0, 0)

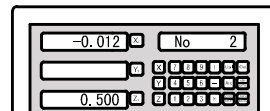



Step 9: Press the  and  keys to display the position of the next point or the last point. Turn the machine tool until displaying zero.

Step 10: Press the  key to exit ARC function at anytime.

4.4 Simple R function

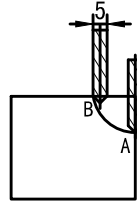
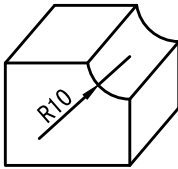
Example 2: Take machining the arc shown in the figure as example:



Step 1: Place the tool directly opposite to the starting point (A or B) of the arc, then press the  key to enter ARC function. Select the simple R function, and press the  key for confirmation.

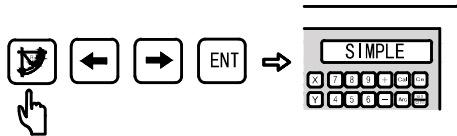

Step 2: Select R machining type

The starting point is A

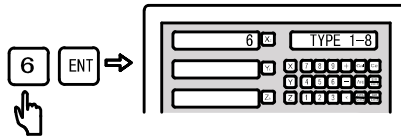

The starting point is B

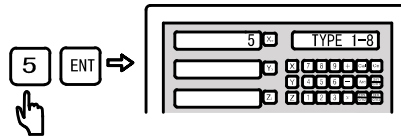

Step 3: Select XZ plane for machining

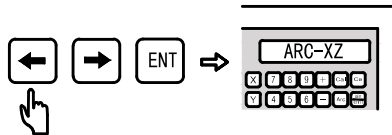

Step 4: Input the arc radius R

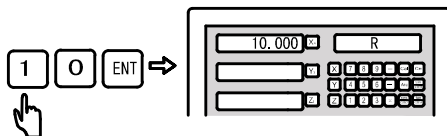

4.4 Simple R function

Step 5: Input the TL-DIA

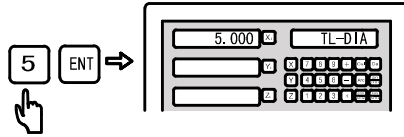

Step 6: Input the MAX-CUT

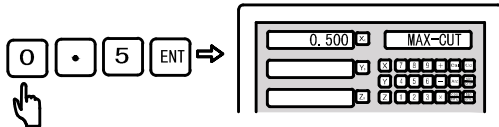

Step 7: Select the convex as the machining plane

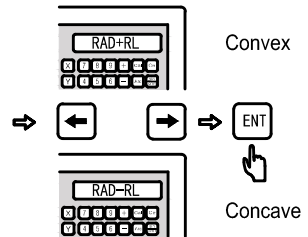

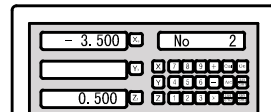

Step 8: Enter machining point

Take A as the starting point (0, 0)

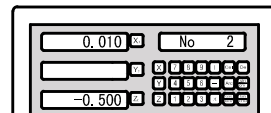

Take B as the starting point (0, 0)



Step 9: Press the  and  keys to display the position of the next point or the last point. Turn the machine tool until displaying zero.

Step 10: Press the  key to exit ARC function at anytime.

Rectangle Chambering

4.5 Rectangle Chambering

4.5 Rectangle Chambering (Applicable to: milling machine)

For machining the work piece chamber shown in figure A, the chambering function may be used. Operators can operate conveniently following the prompts. Shown in figure B, the machining starts from the chamber center and proceeds along the direction indicated by the arrow. The machining can be finished only after simple 11 steps. The completion of the machining is shown in figure C. From in figure C, the machined part is just the external rim of the chamber, so operators need to cut off the uncut part from the chamber center manually.

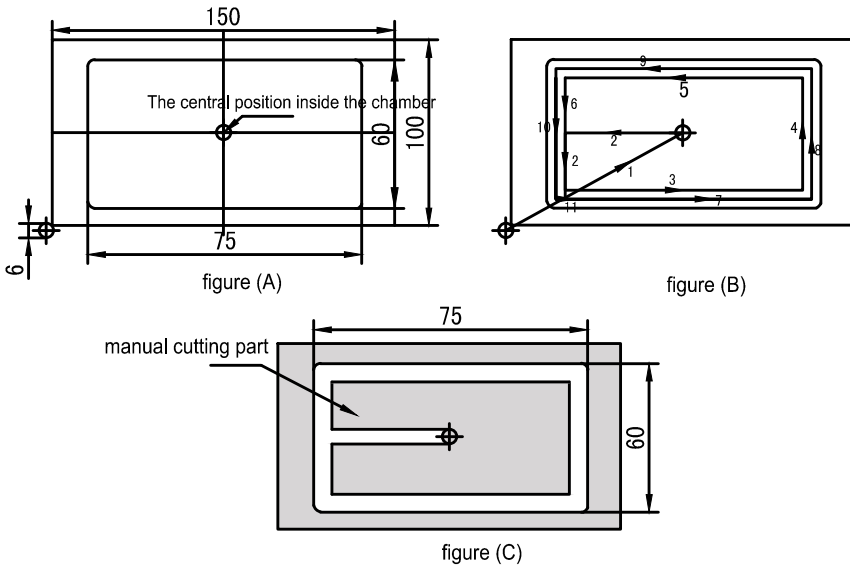

Example: For machining the work piece shown in figure A, the operating procedures are as follows

- 1: Set the tool according to the position shown in figure A, and zero, then press the  key to enter the chambering function.
- 2: Input the TL-DIA =6.
- 3: Select the XY plane as the machining plane (2-axis DROs do not contain this selection).
- 4: Input the chamber central position CT-POS (78.00, 53.00).
- 5: Input the chamber SIZE (75.000, 60.000).
- 6: Enter the machining state.

4.5 Rectangle Chambering

Step 1: Set the tool according to the position shown in figure A, and zero, then press the  key to enter the chambering function.

Step 2: Input the TL-DIA

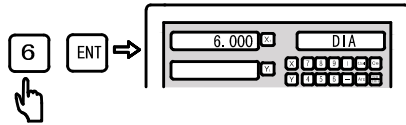

Step 3: Select the machining plane (2-axis DROs do not contain this selection)

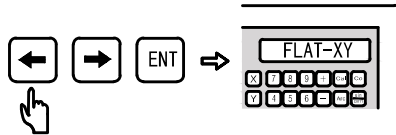

Step 4: Input the chamber central position

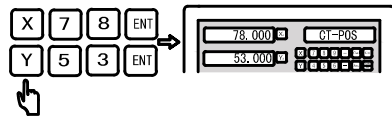

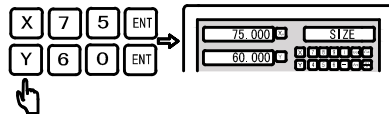

Step 5: Input the chamber size

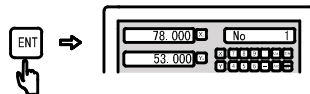

Step 6: Enter the machining state



Step 7: Press the  and  keys to display the next machining position, and then move the machine tool following the prompts until X axis and Y axis display zero.

Press the  key to exit the chambering function anytime.

Bevel Machining

4.6 Bevel Machining

4.6 Bevel Machining function (Applicable to: milling machine)

For machining a large bevel, it's very easy and simple with the help of bevel machining function. However, the bevel machining function only offers XY plane machining.

— Inclination Correction on the Bevel

When machining the work pieces shown in figure (A) on XY plane, firstly correct the inclination angle of the work pieces before the bevel machining. In this case, the bevel machining function acts as the inclination correction on the bevel.

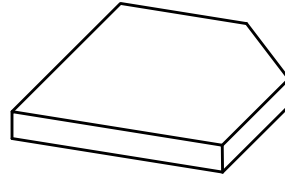



figure (A)

Procedures for the inclination correction on the bevel:

Firstly, place the work pieces on the table roughly according to the desired inclined angle.

1. Press the  key to enter the bevel machining function.
2. Select XY plane as the machining plane.
3. Input the inclined angle.
4. Move the table to make the measuring tools (such as the dial indicator) installed and clamped on the milling machine touch point A on the corrected bevel lightly and set the measuring tools to zero, then move the table at any distance in the direction of X axis.
5. Press the  key to display the value in the direction of Y axis and then move the table until displaying zero.
6. Adjust the work pieces angle, rotate the work pieces by taking point A as the supporting point to touch the measuring tools and set the measuring tools to zero.

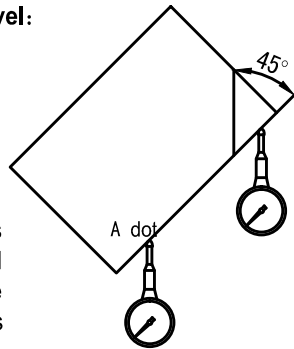

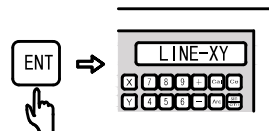

figure (B)

Example: Correct the work piece inclination to 45° shown in figure (B).

Step 1: Place the work piece on the table roughly at 45°. Press the  key to enter the bevel machining function.

Step 2: Select the XY plane as the machining plane, (Note: the DRO only offers XY plane).



4.6 Bevel Machining

Step 3: Input the bevel angle

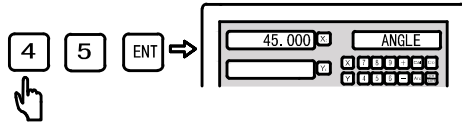

Step 4: Move the table in the direction of X axis to make the measuring tools touch the work piece lightly. After setting measuring tools to zero, move the table at any distance in the direction of X axis.



Step 5: Press the **[Y]** key to calculate the moving distance in the direction of Y axis. Move Y axis until displaying zero.

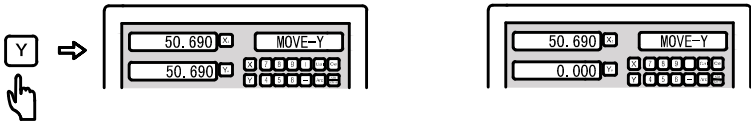

Step 6: Adjust the work piece angle, and rotate the work piece by taking point A as the supporting point to make the corrected bevel touch the measuring tools until the angle is at 0°.

Step 7: Move the table until Y axis displays zero.

Press the **[$\frac{mm}{cm}$]** key to exit the bevel machining function anytime.

Calculator

4.7 Calculator

4.7 Calculator Function

You may encounter with the situation that some numerical value needs to be calculated in working. The DRO has the built-in calculator function which includes the simple arithmetical operations such as addition, subtraction, multiplication and division and the calculation such as trigonometric function, anti-trigonometric function and square root, etc.

The key layout on the calculator panel:

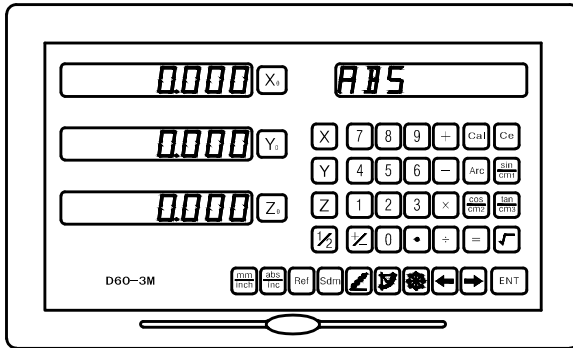





Introduction about the function keys:



All calculation is performed on the menu window



 Calculation function key: Press this key to enter the calculation function. While, you could exit the calculation function by pressing this key.

 Calculate the square root.

 Anti-trigonometric function calculation: Press this key and then press the trigonometric function key to restore the trigonometric function.

   Trigonometric function key.

 Delete the input and delete the last calculation result;  can be used to delete the current digit.

 ,  and  Data axis transferring: you may transfer the calculated value to X axis, Y axis and Z axis.

Example 1: Press the  key to enter the calculation function

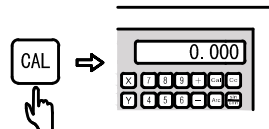

4.7 Calculator

Perform the following calculation after entering the calculation function:

$$10+10\div 2\times 5=35$$

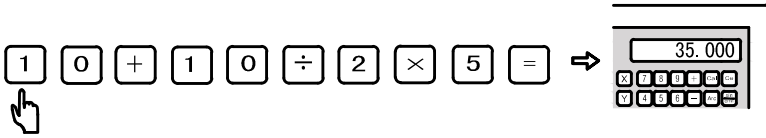

Example 2: Calculate $\sin 45 = 0.707$

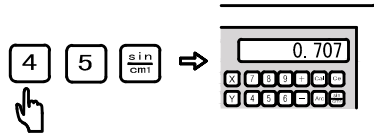

Example 3: Restore the trigonometric function $\text{ARC sin } 0.707 = 44.991$

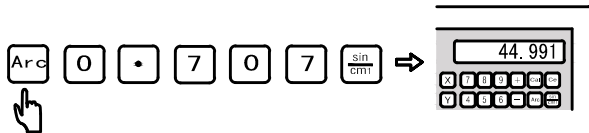

Example 4: Calculation $\sqrt{10} = 3.162$

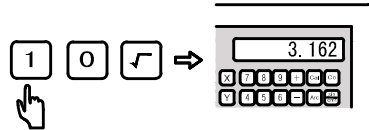

Example 5: Transfer the calculated results to X axis, Y axis and Y axis for displaying respectively, Transfer the calculated result 3.162 in example 4 to X axis, Y axis and Y axis respectively

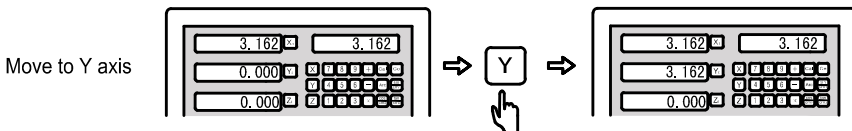
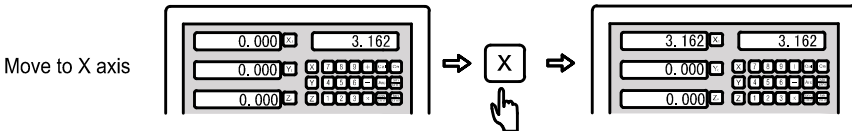

4.7 Calculator

Move to Z axis

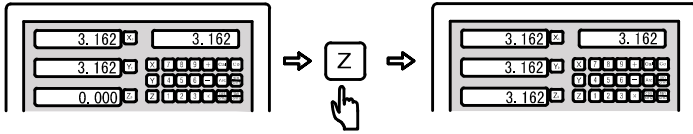

Example 6: Zero the calculated value

Full zeroing

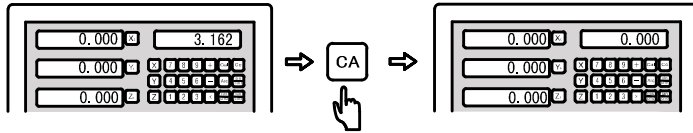

Single step zeroing: The single step zeroing only applies to D60-3V or D60-2V DROs and does not apply to D60-3M or D60-2M DROs.

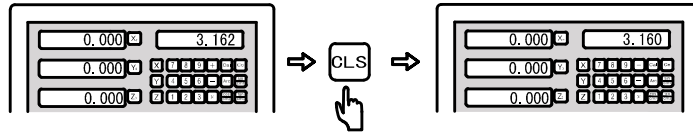

Example 7: Exit the calculator function

Press the  key to exit the calculator function

Note: When the input value or the calculated results exceed the displaying scope, the displayed value is in error and the calculator column displays “E”. At this moment, press the  key to restore the normality.

The calculated results exceed the displaying scope

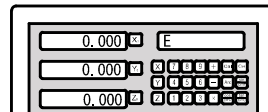

Digital filtering function

4.8.1 Digital filtering function

4.8.1 Digital filtering function (Applicable to D60-2G DRO)

Function introduction:

The vibration of the grinding machine in grinding process causes the display on the DRO changing repeatedly and fast, which leads to visual discomfort of operator. Special function of grinding machine in the DRO has digital filtering function known as “Debouncing function”. During the vibration of the grinding machine, the function could prevent the DRO from changing fast to avoid visual confusion.

The operator could adopt digital filtering function according to the following procedures during grinding process.

Step 1: Press  key to enter the digital filtering function

Enter the digital filtering function The right window will display mark “

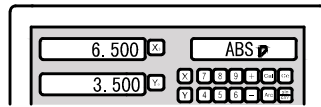

Step 2: Exit the digital filtering function
The mark “

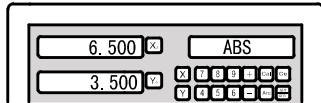

Note: The digital filtering function could be used only under ABS, INC and SDM states. Once the digital filtering function is used, other functions could not be used simultaneously.

200 sets of tool magazine

4.9.1 200 sets of tool magazine

4.9.1 200 sets of tools

(Applicable to D60-2L and D60-3L DROs)

Function introduction:

Various tools are needed to turn different work pieces or their surface, so we have to load/unload tools and set tools. To save the operator's time, the lathe function of the DRO is provided with the function of 200 sets of tool magazine.

Note: The function of 200 sets of tool magazine could only be used together with a tool post on the lathe. Don't use this function without a tool post to avoid errors in machining.

Basic settings:

1. Set a reference tool. After setting the reference tool, clear X and Y axis and set the reference tool at the ABS zero point.
2. Determine the position of the tool relative to the reference tool and ABS zero point according to the location size of the tool and reference tool. As shown in Figure (A), the relative location size of tool 2 can be calculated as: X axis $25-30=-5$, Y axis $20-10=10$.

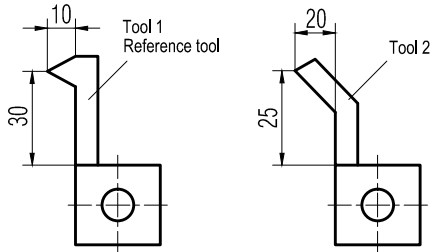

Figure (A)

3. Number the tools and store the relative location size of the tool and reference tool into the DRO.
4. During the machining process, the operator could input any number of the called tool and the DRO will display the location size of the currently called tool and ABS zero point. Move the lathe carriage until X and Y axis display zero.
5. The tool magazine could store materials of 200 sets of tools.

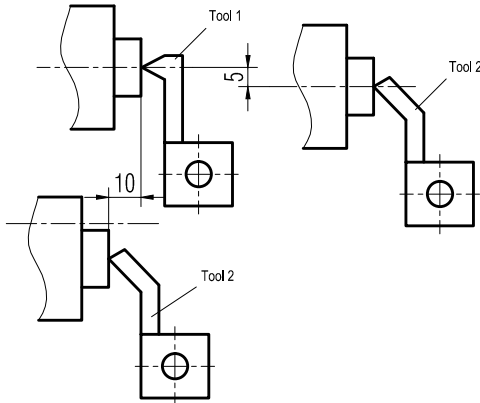





Figure (B)

4.9.1 200 sets of tool magazine

6. Press the  key ten times continuously then the DRO will display TL-OPEN and the right information window will display “”, which indicates that the tool magazine function has been started. After starting the tool magazine function, press the  key ten times continuously then the DRO will display TL-OPEN and “” on the top left corner in the right information window will disappear, which indicates that the tool magazine function has been closed.

Note: The Y axis value mentioned above is actually a numerical synthesis of Y and Z axis, i.e. the former Z axis.

Input the tool data and call the tool according to the following operations:

- Step 1: Input the tool under ABS state. Set tool 1 under ABS state and clear zero, then set tool 1 as the reference tool.

- Step 2: Press  key to enter the setting state of the tool magazine.

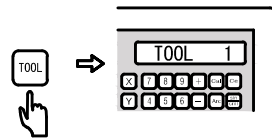

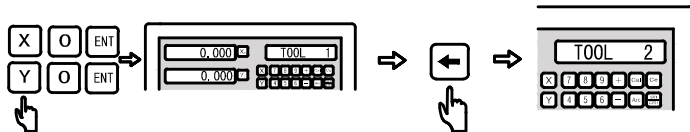

- Step 3: Input tool data.

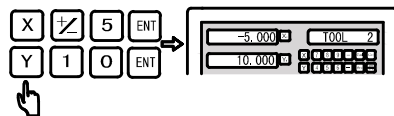

- Step 4: Input TOOL 2 information.





- Step 5: Press  key to input the next tool data. Press  key to exit input state.

After inputting the tool data, use the tool magazine according to the following operations and clamp the second tool firstly.

- Step 1: Press  key to enter the tool magazine using state. You can input the number directly to select the required tool and press  key to enter the next level of menu.

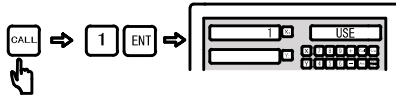
4.9.1 200 sets of tool magazine



Step 2: Press  and  key to select the reference tool relative to the currently used tool. You could also input the corresponding value to select the reference tool when the right window displays BASE state.

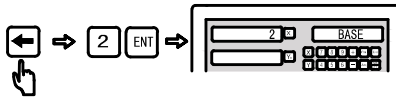

Step 3: Press  key to exit this function. Move the table until X and Y axis display zero. The second tool has been set at the reference position. Likewise, the operator could input and call 200 tools.

Note: You could only zero under ABS state when the used tool (USE) is the same with the reference tool (BASE) or you can only zero under INC state.

Taper measuring

4.9.2 Taper measuring

4.9.2 Taper measuring (Applicable to D60-2L and D60-3L DROs)

Function:

The function is used to turn tapered work piece and could measure the taper of the work piece in machining.

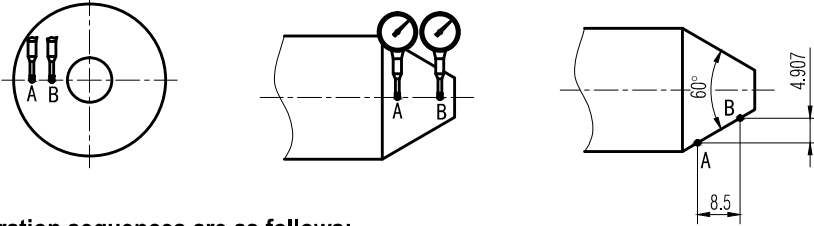

Operation sequences are as follows:

As shown in the figure, make the contact of the lever indicator to contact position A on the work piece surface and press until the lever indicator points to zero.

Step 1: Press  key to enter taper measuring function.

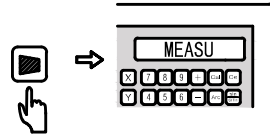

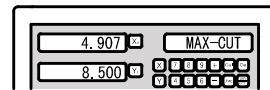

Step 2: Move the table to press the position B on the work piece surface until the lever indicator points to zero.

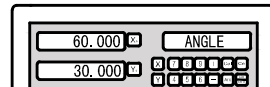

Step 3: Calculate and press  key.

X axis displays the taper.
Y axis displays the angle.



Step 4: Press  key to exit taper measuring.

Diameter/radiusConversion

4.9.3 Diameter /radiusConversion

4.9.3 Diameter/radius Conversion (Applicable to D60-2L and D60-3L DROs)

Function introduction:

When the DRO is set as lathe meter, $\frac{1}{2}$ key has specific functions. Press \boxed{X} key firstly and then $\frac{1}{2}$ key, display of the X axis will convert to radius and the right menu window will display mark “ $\frac{1}{2}$ ”. Press \boxed{X} key firstly and then $\frac{1}{2}$ key, display of the X axis will convert to diameter and the mark “ $\frac{1}{2}$ ” on the right menu window will disappear.

Example: Radius/diameter

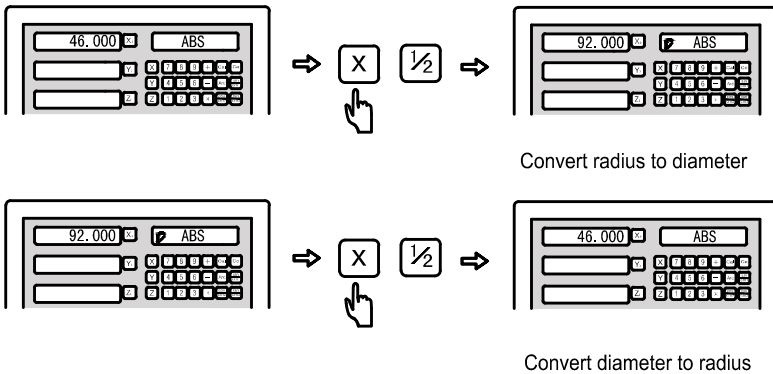





Note: When the DRO is used as a lathe meter, only the X axis has radius/diameter conversion and Y and Z axis don't have this function.

4.9.3 Diameter /radiusConversion

4.9.4 Y + Z function (Applicable to D60-3L DRO)

Function introduction:

When the DRO is used as a 3-axis lathe meter, the calculated value of Y and Z axis could be combined and displayed on Y axis. Press  key, the value of Y and Z axis will be combined and displayed on Y axis and the right menu window will display a “” mark. Press  key again, the mark “” on the right menu window will disappear and the display will back to normal.

Example: Y + Z function

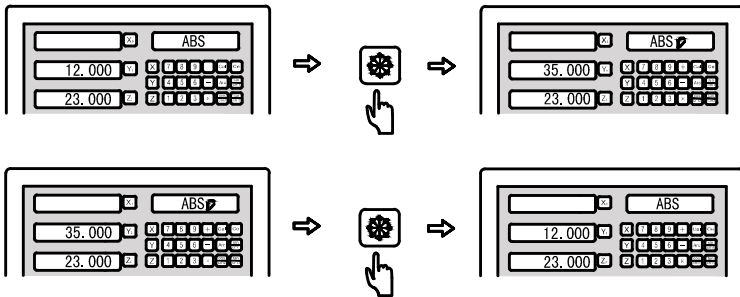

Congruous Output Function of EDM

4.10 Congruous Output Function of EDM

4.10.1 Congruous Output Function of EDM (Applicable to D60-3E DRO)

1. Function introduction:

This function is used for the specialized machining by the electric discharge machine (i.e. EDM). When the target value on Z axis of the EDM equals the current value, the DRO will output a switch signal to control the EDM to stop the depth machining.

The setting for Z axis direction of D60-3E type DRO is shown in figure 1, i.e., the depth is larger, the coordinate value displayed by Z axis is larger. Since the machining is started, as the depth increases gradually, the value displayed by Z axis increases gradually.

According to the set direction on the Z axis, the machining direction includes the positive direction and negative direction. When the electrode drops, the machining direction is from upper to lower part, and the DRO value will increase. We call the machining direction as "positive direction machining" which is the normal direction. When the electrode rises, the machining direction is from lower to upper part, and the DRO value will decrease. We call the machining direction as "Negative", namely, "negative direction machining" (as shown in figure1).

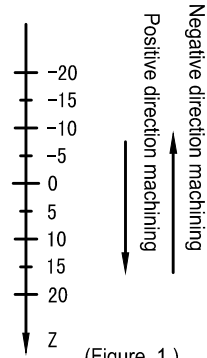

(Figure 1)

The D60-3E DRO with EDM function also has the function of "reverse fire prevention height" which is not offered by other similar DROs. This function is one kind of intelligent safety protection device of position following and detecting. When the carbon deposition occurs on the electrode surface in the process of positive direction machining, especially in the long-time machining or

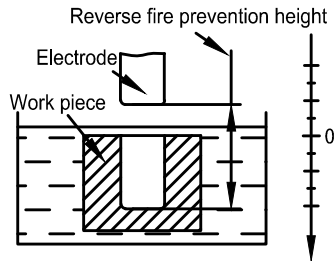





(Figure 2)

round-the-clock machining without supervision by people, the carbon deposition will increase gradually along the reverse direction without being cleared up by people. Once the electrode exceeds the liquid level, the fire may tend to break out to cause the damage. This "reverse fire prevention height" function is set for this problem. If the "reverse fire prevention height" is set, the DRO will give a warning and an alarm when the height enhanced by the electrode exceeds the height (i.e., the reverse fire prevention height) between electrode and the machined plane depth. Meanwhile, the output signal will shut down the EDM automatically to completely eradicate the chance of fire breaking out. (See figure 2)



4.10 Congruous Output Function of EDM

2. Specific Operations:

- 1: Before machining, set the parameters of "reverse fire prevention height", "exit mode", "machining direction" and "EDM mode".
- 2: Firstly move the main axis electrode of Z axis to make it touch the work piece reference, and then zero Z axis or set the number.
- 3: Press the  key, and input the depth value for machining (the depth value will be displayed on X axis), such as 10.00, then press the  key to confirm. After the confirmation, press the  again to exit "DEPTH" and enter "EDM" state for machining.
- 4: "The target value of the machining depth" will be displayed on X axis. will be displayed on Y axis. The value on Y axis is the machined depth value of the work piece. will be displayed on Z axis. Note: The value on Z axis is the value of position where the main axis electrode of Z axis is located.
- 5: After the machining is started, the value displayed on Z axis will get on for the target value gradually. If the electrode rises and drops repeatedly at this moment, the value displayed on Z axis will change accordingly. However, the value displayed on Y axis will not change and always indicate the machined depth value.
- 6: When the value displayed on Z axis equals the target value, the limit switch will close, and the EDM will stop machining, also, the information screen will display "EDM END". According to the setting made by the operators, there have two exit modes: I. Automatic mode. Exit the EDM machining state automatically and restore the displaying state before machining. II. Pause mode. The screen always shows "EDM END", and it need to press the  key to exit and restore the original displaying state.

3. Set the "reverse fire prevention height (ERRHIGH)", exit mode and machining direction:

Before machining, set the "reverse fire prevention height (ERRHIGH)", "exit mode" and "machining direction" at first:

Step 1: Zero the coordinate of every axis and then press the  key to enter into the "EDM" function. Press the  and  keys to enter the "EDM" menu setting.

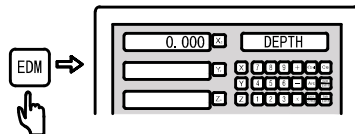

4.10 Congruous Output Function of EDM

Step 2: press the  key to enter the setting mode, and set the “reverse fire prevention height” and input the height value “-150”.

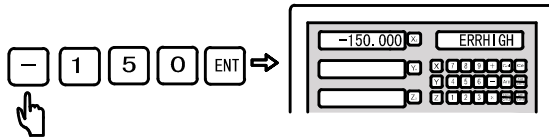

Step 3: Set the positive, negative directions and the current setting is the positive direction machining.

Negative machining direction (NEGRTIV)
Press the  key to select

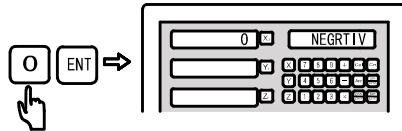

Positive machining direction (POSITIV)
Press the  key to select

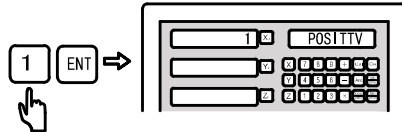



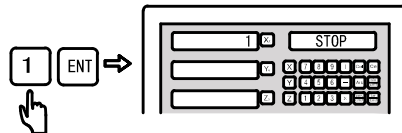

Step 4: Enter the setting of “exit mode”, and the current setting is “automatic mode”.

Pause mode

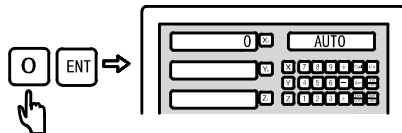

Automatic mode



“AUTO” refers to the automatic mode and “STOP” refers to the pause mode. If the original exit mode is “pause mode”, the word “STOP” will appear. Press the  key, the mode could be switched to the “automatic mode”, and the word “AUTO” will appear. For mode selection, you can press the  or  keys to switch.

Step 5: Select the EDM machining mode, and the current setting is MODE 0.

4.10 Congruous Output Function of EDM

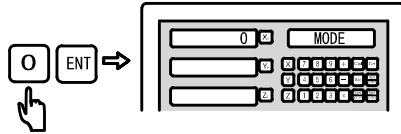

Press the **0** key to select MODE 0. The output states of the relay in MODE 0 are as follows:

- When the power is off, the relay coil is OFF.
- When the CPU is not initialized, the relay coil is OFF.
- When the normal state output of booting is 1, the relay coil is ON.
- When EDM function outputs 0 in operation, the relay coil is ON.
- When EDM outputs 0 in depth, the relay coil is OFF.

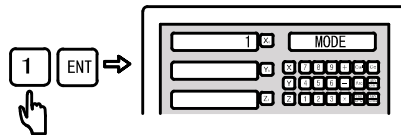

Press the **1** key to select MODE 1. The output states of the relay in MODE 1 are as follows:

- When the power is off, the relay coil is OFF.
- When the CPU is not initialized, the relay coil is OFF.
- When the normal state output of booting is 0, the relay coil is OFF.
- When EDM function outputs 1 in operation, the relay coil is ON.
- When EDM outputs 0 in depth, the relay coil is OFF.

The machining defaulted by the DRO is the positive direction machining. As in example 1 and example 2, you should set the positive direction machining as the machining at first in the positive direction machining; as the work piece shown in the machining figure (F), you should set the negative direction machining as the machining direction before machining in the negative direction machining. Otherwise, after entering the machining, the DRO will identify that the machining has been completed and exit the machining.

Step 6: Press the **EDM** key to exit the setting to restore the original state.

4. Examples of Positive Direction Machining

Example 1: Machining the work piece as shown in Figure (A), The work piece and electrode are shown in figure (B). Please set the positive direction machining as the machining direction at first.

4.10 Congruous Output Function of EDM

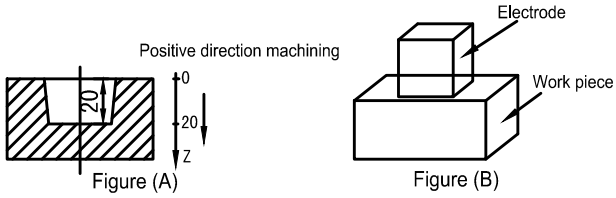

Step 1: As shown in figure (B), move the main axis electrode to make it touch the work piece and then press the **X** , **Y** and **Z** keys to zero.

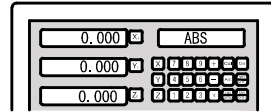

Step 2: Press the **EDM** key to enter the machining.

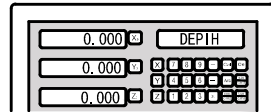

Step 3: Set the machining depth.

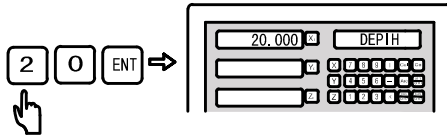

Step 4: Start to machine.

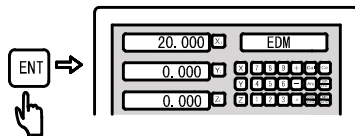

Step 5: When the value displayed on Z axis equals the target value, the limit switch will close; the information window on the right will display “EDM END” for 3 seconds, then back to the state before machining.

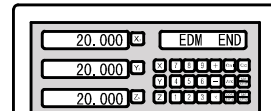

Three seconds later, the information window will exit the EDM machining state and back to the ABS displaying state.

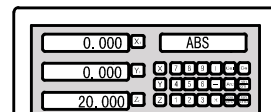

4.10 Congruous Output Function of EDM

Example 2: Machining the work pieces as shown in Figure (C)

Please set the positive direction machining as the machining direction at first.

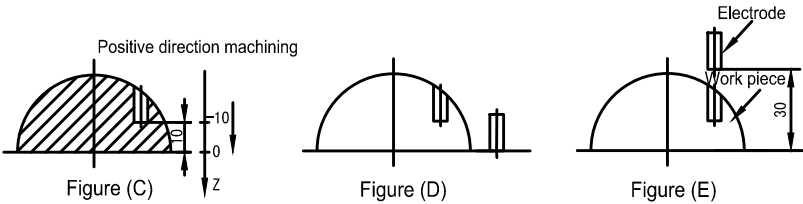

Step 1: As shown in figure (D), move the main axis electrode to make it touch the machining size reference position of the work pieces and press the **[Z]** key to zero.

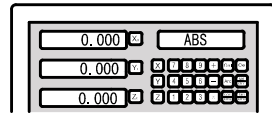

Move the electrode to the position shown in figure (E)

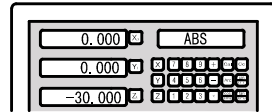

Step 2: Press the **[EDM]** key to enter the machining

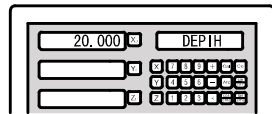

Step 3: Set the machining depth

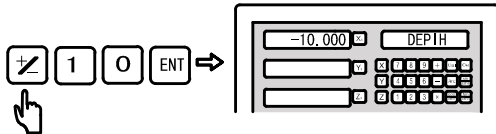

Step 4: Start to machine

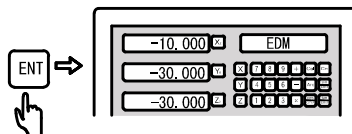

4.10 Congruous Output Function of EDM

Step 5: When the value displayed on Z axis equals the target value, the limit switch will close; the information window on the right will display “EDM END” for 3 seconds, then back to the state before machining.

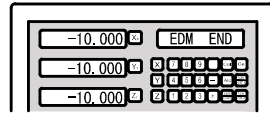

Three seconds later, the information window will exit the EDM machining state and back to the ABS displaying state.

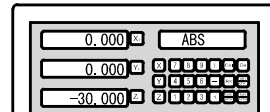

5. Examples of Negative Direction Machining

Example 3: Machining the work pieces as shown in Figure (F) ,Please set the negative direction machining as the machining direction.

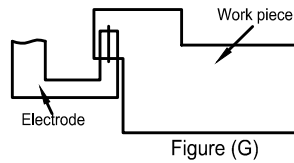
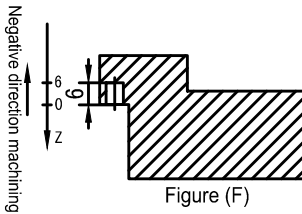

Step 1: As shown in figure (G), move the main axis electrode to make it touch the machining size reference position of the work piece and press the **Z** key to zero.

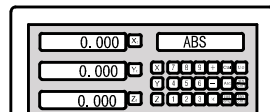

Step 2: Press the **EDM** key to enter the machining.

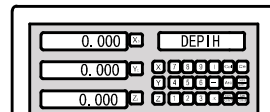

4.10 Congruous Output Function of EDM

Step 3: Set the machining depth.

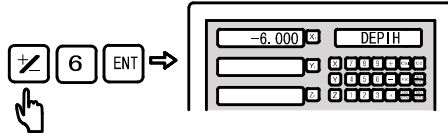

Step 4: Start to machine.

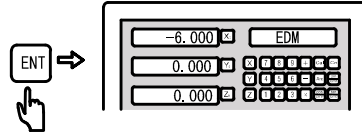

Step 5: When the value displayed on Z axis equals the target value, the limit switch will close; the information window on the right will display “EDM END” for 3 seconds, then back to the state before machining.

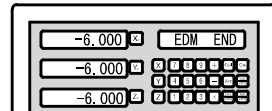



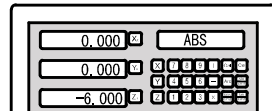

Three seconds later, the information window will exit the EDM machining state and back to the ABS displaying state.



6. Use PCD Function together with EDM Function





In PCD function, the DRO can call the EDM function to complete the EDM machining for the PCD. The specific operation procedures are as follows:

- 1) Press the  key to enter the PCD function to set parameters (please refer to the PCD function setting). After setting all parameters, press the  key to enter the PCD machining. When displaying the position coordinate of the first machining, move the table to make the electrode aligning the first machining hole.
- 2) Press the  key to input the EDM parameter setting and machining state (refer to the EDM parameter setting for the EDM parameter setting method), and input the machining depth for EDM machining. After the machining is completed, press the  key to exit EDM machining and enter the PCD machining. Press the  key to display the position coordinate of the second hole. Move the table to make the electrode aligning the next machining hole.



4.10 Congruous Output Function of EDM

7. Use PLD Function and EDM Function Cooperatively

In PLD function, the DRO can call the EDM function to complete the EDM machining for the PLD. The specific operation procedures are as follows:

- 1) Press the  key to enter the PLD function to set parameters (please refer to the PLD function setting). After setting all parameters, press the  key to confirm entering the PCD machining. The position of first machining hole is displayed in coordinate. Then move the table to make the electrode aligning the first machining hole.
- 2) Press the  key to enter the EDM parameter setting and machining state (refer to the EDM parameter setting for the EDM parameter setting method), and input the machining depth for EDM machining. After the machining is completed, press the  key to exit EDM machining and enter the PLD machining. Press the  key to display the position coordinate of the second hole. Move the table to make the electrode aligning the next machining hole.

8. Function of Switching Displaying Mode

In the EDM machining, the operators may press the  key if they want to know the coordinate condition of external XY plane. If the information window displays "EDM-P", the values displayed on X axis and Y axis are the values of the external XY plane. Press the  key again to restore the EDM displaying mode. This function is only limited to switching the displaying mode and does not affect the EDM machining.

9. EQUAL OUT port of rear base plate

The output of EQUAL OUT is the relay output and the contact capacity is: 1.0A30VC, 0.5A125VAC, 0.3A60VDC.

9-pins Socket Pin Number	Signal type	9-pins lead
1	OFF (NC Port)	Black
3	COM (Common Port)	Yellow
5	NO (NO Port)	Red

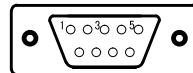

Rotate Speed Measurement

5.D70-4V rotate speed measurement function

5.1 Brief Introduction Operation Processes

(It can be used for milling machine, lathe machine,grinding machine)

1. Functions Introduction:

When machining a workpiece, the rotate speed of machine tools motor would be different sometimes, It will cause the different roughness of the workpiece ,then the precision of workpiece will be reduced. Operator could adjust the motor rotate speed to improve the glossiness of the workpiece, so as to make the surface of the workpiece smooth. D70-4V digital readout has rotate speed real-time monitoring function, helping the operator know the principal axis current rotate speed promptly.

2. Operation Process

Step 1: In the mode of ABS/INC/SDM, Press RPM button to enter rotate measurement function

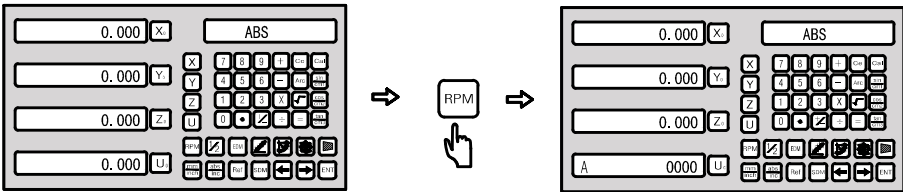

When U axis displaying A expresses the U axis entering rotate speed measurement mode, at the same time U axis would show the current principal axis rotate speed.

Step 2: Exiting Rotate Speed Measurement Mode

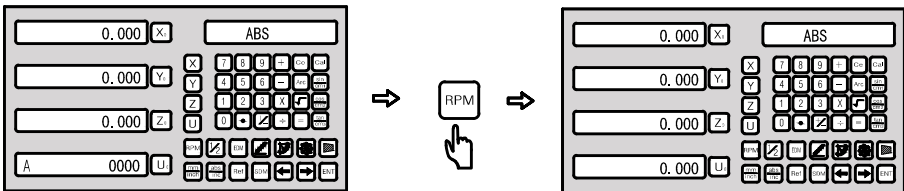

When U axis is in the mode of rotate speed measurement, please press RPM button to exit the rotate speed measurement mode.

5.D70-4V rotate speed measurement function

5.2 The installing drawing of Rotate Measurement Machinery

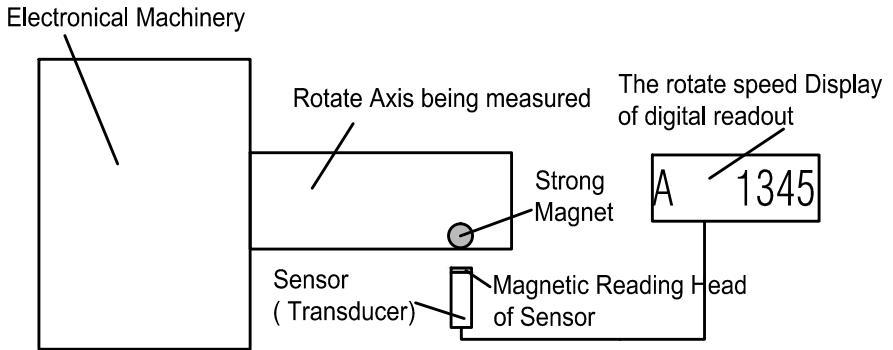

Notice: When the Strong Magnet is installed on the rotate axis to be measured, the space length between the sensor reading head and the strong magnet should be less than 1cm.

Digital Readout Connector Program

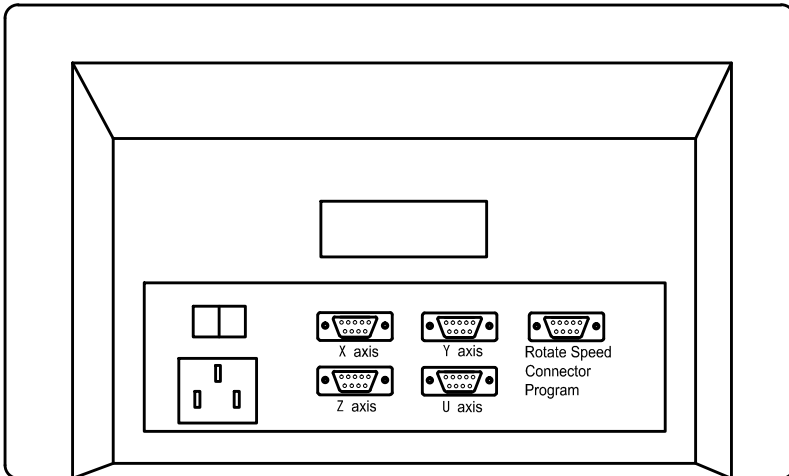

6. Appendix

6.1 Notices for Usage:

1. Supply voltage: AC 80 V -- 260 V, 50 -- 60 Hz
2. Power: 15 W
3. Operating temperature: -10°C -- 60°C
4. Storage temperature: -30°C -- 70°C
5. Relative humidity (RH): <90% (25)>
6. Axis to be displayed : 1 axis, 2-axis , 3-axis and 4-axis
7. Input signal allowed by the DRO: TTL square wave
8. Allowable input signal frequency: < 5 MHz
9. Length resolution: 0.1 um, 0.2 um, 0.5 um, 1 um, 2 um, 2.5 um, 5 um and 10 um
10. Minimum resolution of angle display: 0.0001/ pulse
11. Weight: 2.2 KG
12. Volume size: 300 x 180 x 75 (mm)
13. Interface definition of the grating ruler: (DB 9-pins socket)

Pin	1	2	3	4	5	6	7	8	9
signal	NA	0V	NA	NA	NA	A	+5V	B	R

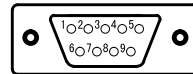

6.2 Installation Figure

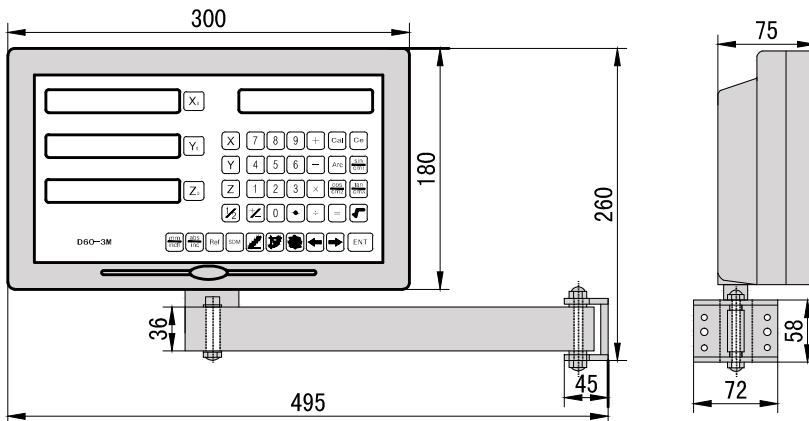

6. Appendix

6.3 Troubleshooting

The following troubleshootings are just the preliminary methods. If the problems still exist, please do not dismantle the DRO by yourself, but contact our company or the dealers for help in time.

Faults	Fault Causes	Solutions
The DRO doesn't display anything	<ol style="list-style-type: none"> 1. The power is not on ? 2. The power switch is not closed ? 3. The supply voltage is not appropriate 4. The internal supply of the grating ruler is in short circuit. 	<ol style="list-style-type: none"> 1. Check whether the power line and power plug are plugged in. 2. Close the power switch. 3. Make sure the supply voltage between 85V-265V. 4. Pull out the connector of the grating ruler.
One axis of the DRO doesn't count	<ol style="list-style-type: none"> 1. Operate the machine after swapping with the grating ruler of another axis. 2. Some special functions of the DRO are being used. 	<ol style="list-style-type: none"> 1. If counting, it's the fault of the grating ruler; if not, it's the fault of the DRO. 2. Exit the special function
The counting of DRO is not accurate (it can't zero)	<ol style="list-style-type: none"> 1. The grating ruler isn't installed according to the requirements or the accuracy is not enough. 2. After being used for a long time, the vibration of the machine tool makes the fixed reading head or the screws loosen. 3. The accuracy of the machine tool is not good. 4. The DRO resolution isn't consistent with the grating ruler. 	<ol style="list-style-type: none"> 1. Reinstall the grating ruler and adjust the level. 2. Tighten all the fixed screws. 3. Overhaul the machine tool. 4. Reset the DRO resolution.
The counting of DRO is in error, The displayed operation distance isn't consistent with the actual distance	<ol style="list-style-type: none"> 1. The machine tool and the DRO shell are not connected to earth. 2. The accuracy of the machine tool is not good. 3. The running speed of the machine tool is too fast. 4. The grating ruler isn't installed according to the requirements and the accuracy is not enough. 5. The DRO resolution isn't consistent with the grating ruler. 6. The operating size unit is not consistent with the displayed Metric/British units. 7. The linear error compensation setting of the DRO is not appropriate. 8. The grating ruler exceeds the operating range of length or the read head is broken. 	<ol style="list-style-type: none"> 1. Connect the machine tool and the DRO shell to earth. 2. Overhaul the machine tool. 3. Reduce the running speed of the machine tool. 4. Reinstall the grating ruler and adjust the level. 5. Reset the DRO resolution. 6. Switch the displayed Metric/British units. 7. Reset the linear error compensation of the DRO. 8. Repair the grating ruler.

6. Appendix

Faults	Fault Causes	Solutions
The grating ruler doesn't count	<ol style="list-style-type: none">1. The grating ruler exceeds the operating range of length or the read head is broken.2. The read head of grating ruler rubs the ruler shell leading to the aluminum scraps accumulated.3. The gap between the read head of grating ruler and the ruler body is too wide.4. The metal tubes of the grating ruler are damaged, which causing the short circuit or disconnection in internal wiring.	<ol style="list-style-type: none">1. Repair the grating ruler2. Repair the grating ruler3. Repair the grating ruler4. Repair the grating ruler
The grating ruler doesn't count sometimes	<ol style="list-style-type: none">1. The small box of the grating ruler is separated from the steel ball.2. The grating glass in the read head of the grating ruler is abraded.3. There is dirt on the grating glass in the shell of the grating ruler.4. The elasticity of small box spring in the read head of the grating ruler is not enough.	<ol style="list-style-type: none">1. Repair the grating ruler2. Repair the grating ruler3. Repair the grating ruler4. Repair the grating ruler